



Beginning black5

for adult only



WHY ARE THESE SECURITY GUARD SMALL-FRIES SPENDING SO MUCH MONEY ON SHIT LIKE THIS...? GOD DAMN...



SHUT UP! YOU BETTER NOT TRIP THE SENSORS WITH THOSE HUGE TITS OF YOURS!

DON'T LET YOUR GUARD DOWN.



ROGER.

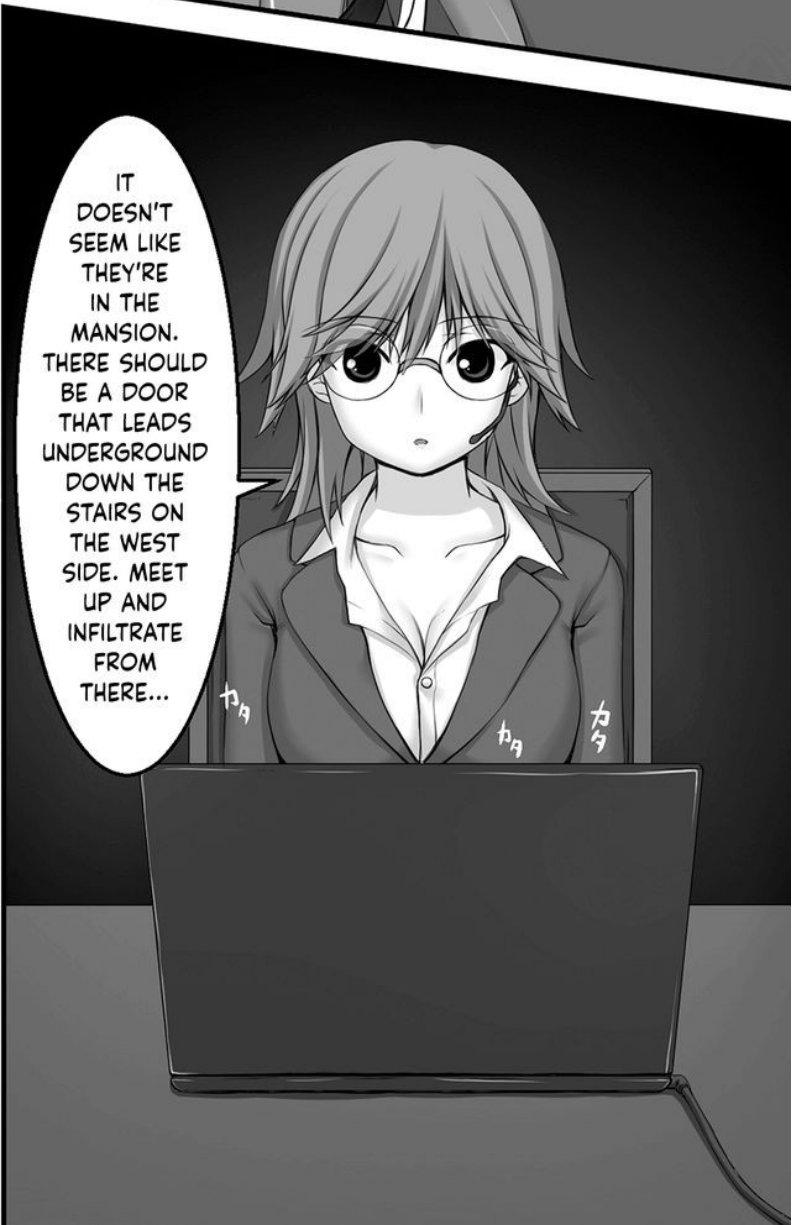

IT DOESN'T SEEM LIKE THEY'RE IN THE MANSION. THERE SHOULD BE A DOOR THAT LEADS UNDERGROUND DOWN THE STAIRS ON THE WEST SIDE. MEET UP AND INFILTRATE FROM THERE...

CREAK

CREAK

CREAK



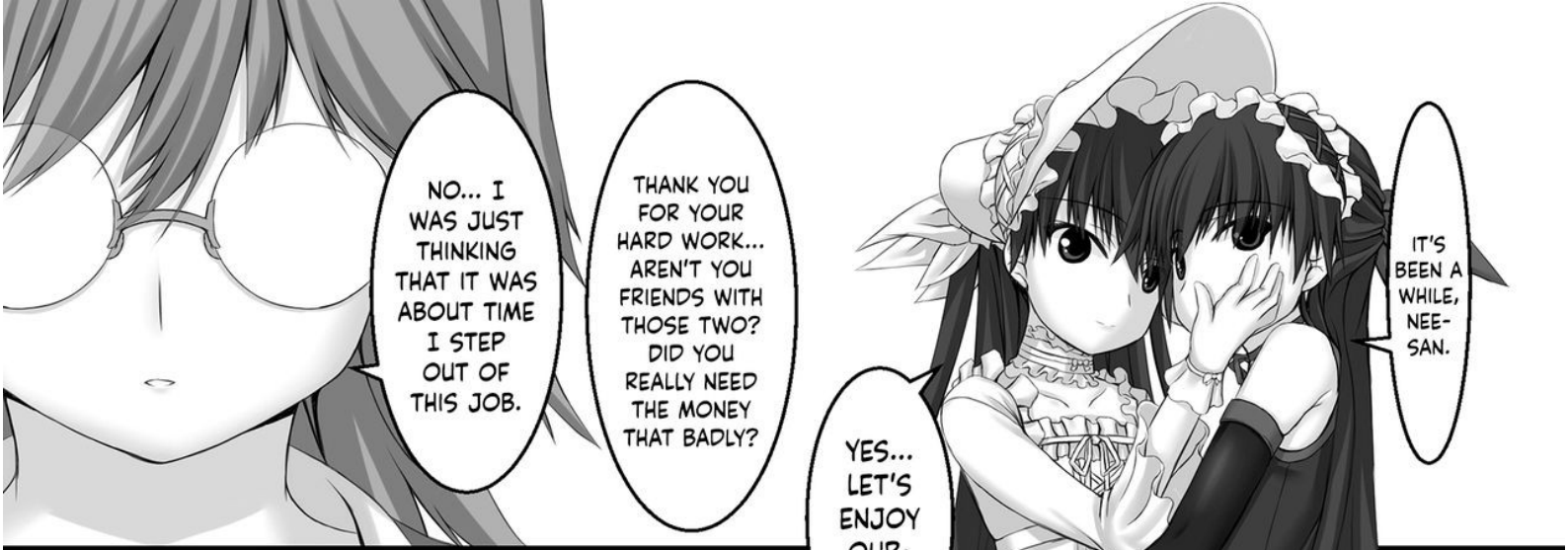

NO... I WAS JUST THINKING THAT IT WAS ABOUT TIME I STEP OUT OF THIS JOB.

THANK YOU FOR YOUR HARD WORK... AREN'T YOU FRIENDS WITH THOSE TWO? DID YOU REALLY NEED THE MONEY THAT BADLY?

YES... LET'S ENJOY OURSELVES.

IT'S BEEN A WHILE, NEE-SAN.

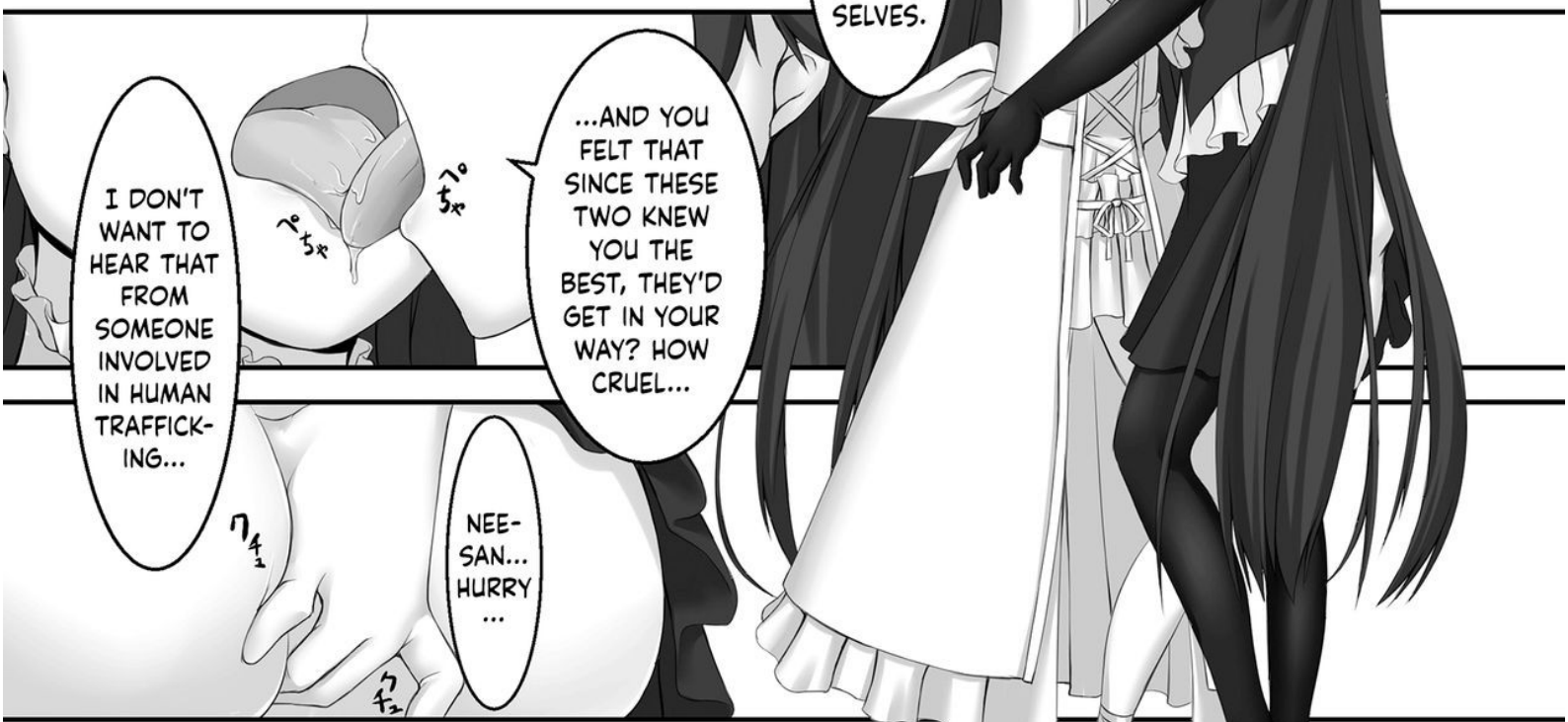

I DON'T WANT TO HEAR THAT FROM SOMEONE INVOLVED IN HUMAN TRAFFICKING...

ねえさん...
ねえさん...
ねえさん...

...AND YOU FELT THAT SINCE THESE TWO KNEW YOU THE BEST, THEY'D GET IN YOUR WAY? HOW CRUEL...

NEE-SAN... HURRY ...

NO... I CAN'T... FROM TODAY ON, I WAS SUPPOSED TO BE WITH THAT PERSON...



HUH...?

YES, IT'S BEEN A WHILE SINCE WE'VE DONE IT WITH THREE PEOPLE AT ONCE.

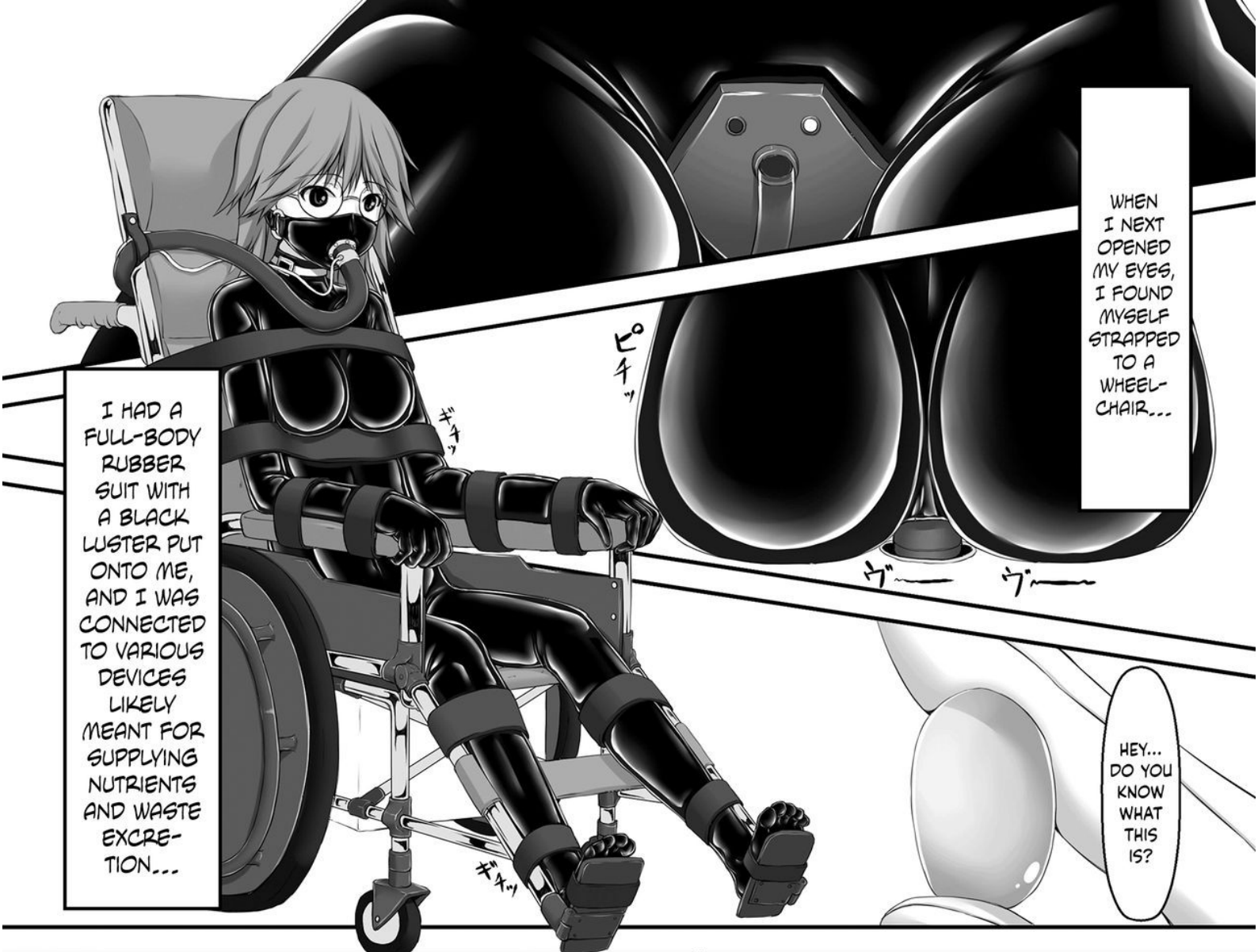

I HAD A FULL-BODY RUBBER SUIT WITH A BLACK LUSTER PUT ONTO ME, AND I WAS CONNECTED TO VARIOUS DEVICES LIKELY MEANT FOR SUPPLYING NUTRIENTS AND WASTE EXCRETION...

WHEN I NEXT OPENED MY EYES, I FOUND MYSELF STRAPPED TO A WHEEL-CHAIR...

HEY... DO YOU KNOW WHAT THIS IS?



BUT IT APPARENTLY GROWS TO BE ABOUT THREE TIMES THE SIZE OF THE WASTE IT ABSORBS. THAT WOULD PROBABLY CAUSE YOUR STOMACH TO BLOW UP, DON'T YOU THINK?



UPON PUTTING IT IN YOUR BUTT, IT ABSORBS YOUR WASTE AND DISSOLVES, ALLOWING YOU TO PROPERLY UNDERGO EXCRETION...

IT'S A LAXATIVE CURRENTLY IN DEVELOPMENT THAT WE RECEIVED FROM A JAPANESE PHARMACEUTICAL COMPANY.

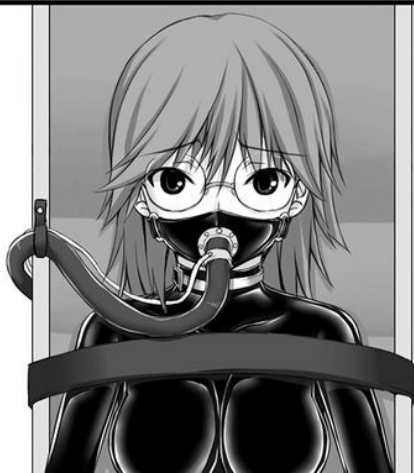

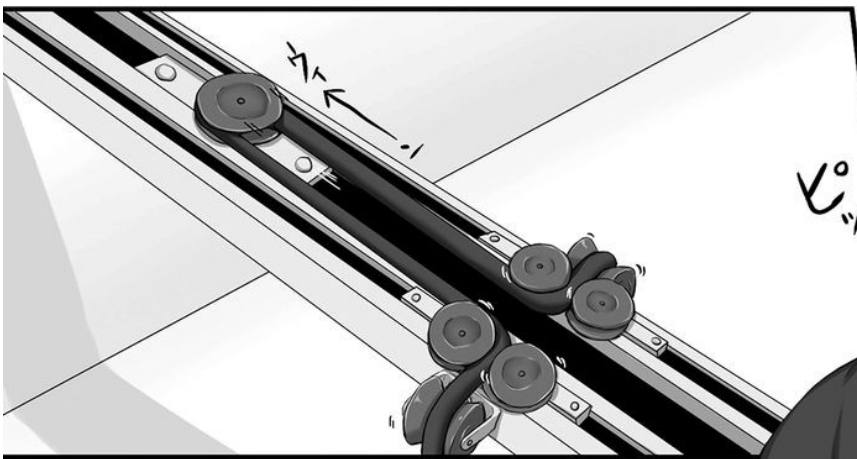

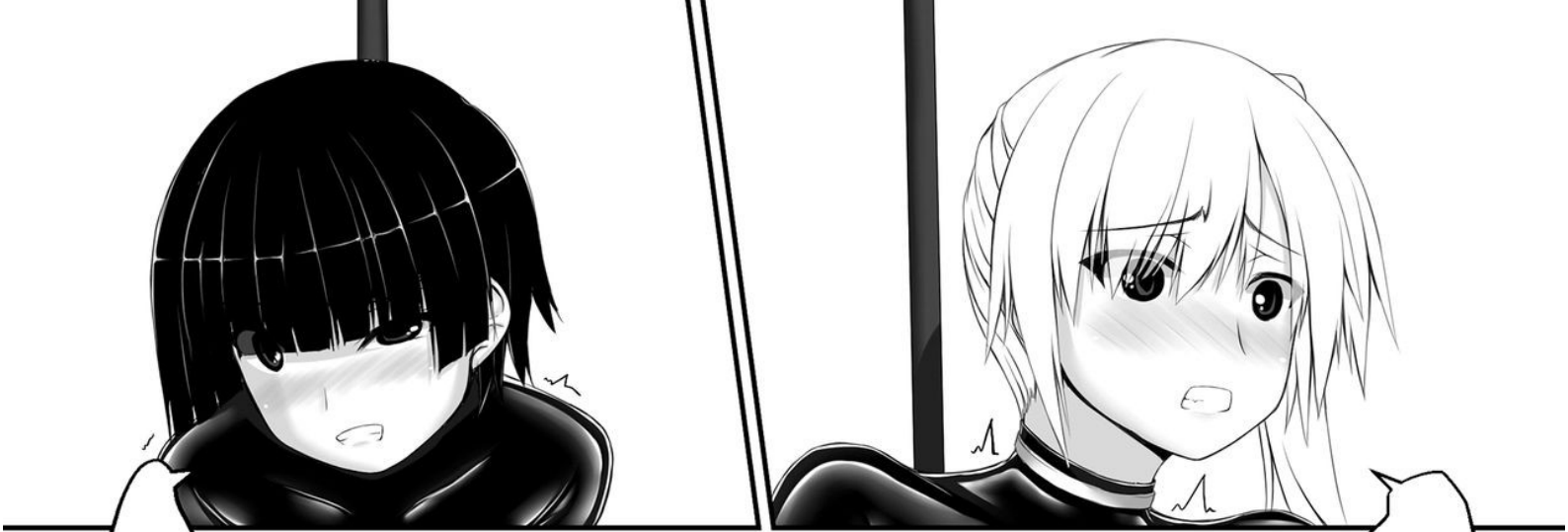

URGH...



AHAHA-HAHA!
YOU TWO JUST CAME, DIDN'T YOU?

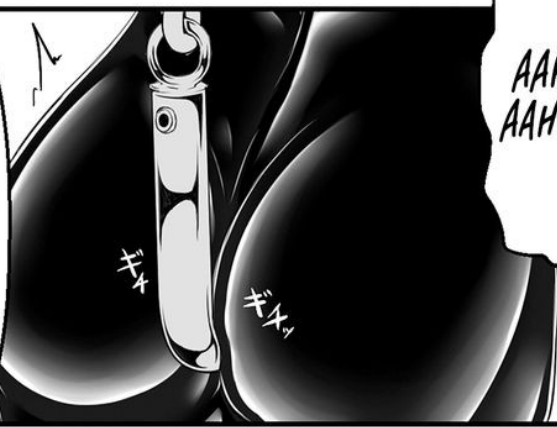

AAH...
AAHHH!



REMEMBER HOW I PUT SOME JELLY IN THERE BEFORE I PUT THE HOOK IN? IT'S GOING TO GET PRETTY BIG, SO DO YOUR BEST.

ALL RIGHT, NEXT I'LL INJECT YOU WITH THIS SOLUTION MADE UP OF APHRODISIAC AND LAXATIVES.

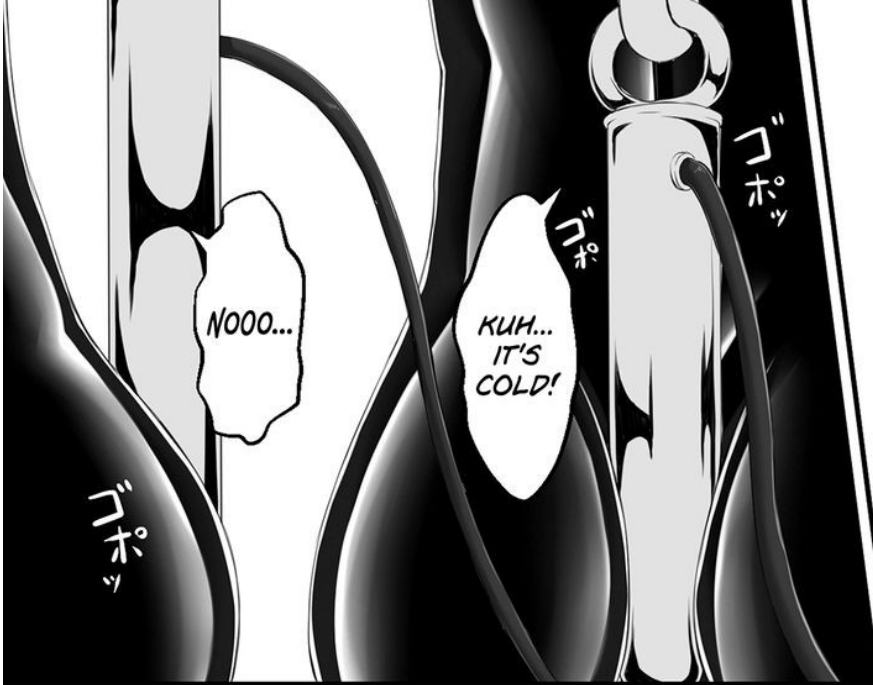



I SHOULD CHANGE FIRST, THOUGH...

HERE COMES AN-OTHER ROUND!

IS SHE GOING TO BREAK THEM AGAIN? I BETTER STOP HER BEFORE THEY BECOME DAMAGED GOODS...



YOU TWO ARE LOOKING PRETTY GOOD...

YOU KNOW, THERE ARE TWO PEOPLE IN THE ROOM NEXT TO US WHO ARE GOING THROUGH THE SAME SITUATION AS YOU...



AS SOON AS SHE LEFT THE ROOM, SOME KIND OF FLUID BEGAN RUNNING DOWN THE HOSE CONNECTED TO MY MOUTH...



I WONDER HOW MANY HOURS I'VE BEEN WATCHING THOSE TWO GIRLS GET THEIR BUTTHOLES RAVAGED BY NOW...

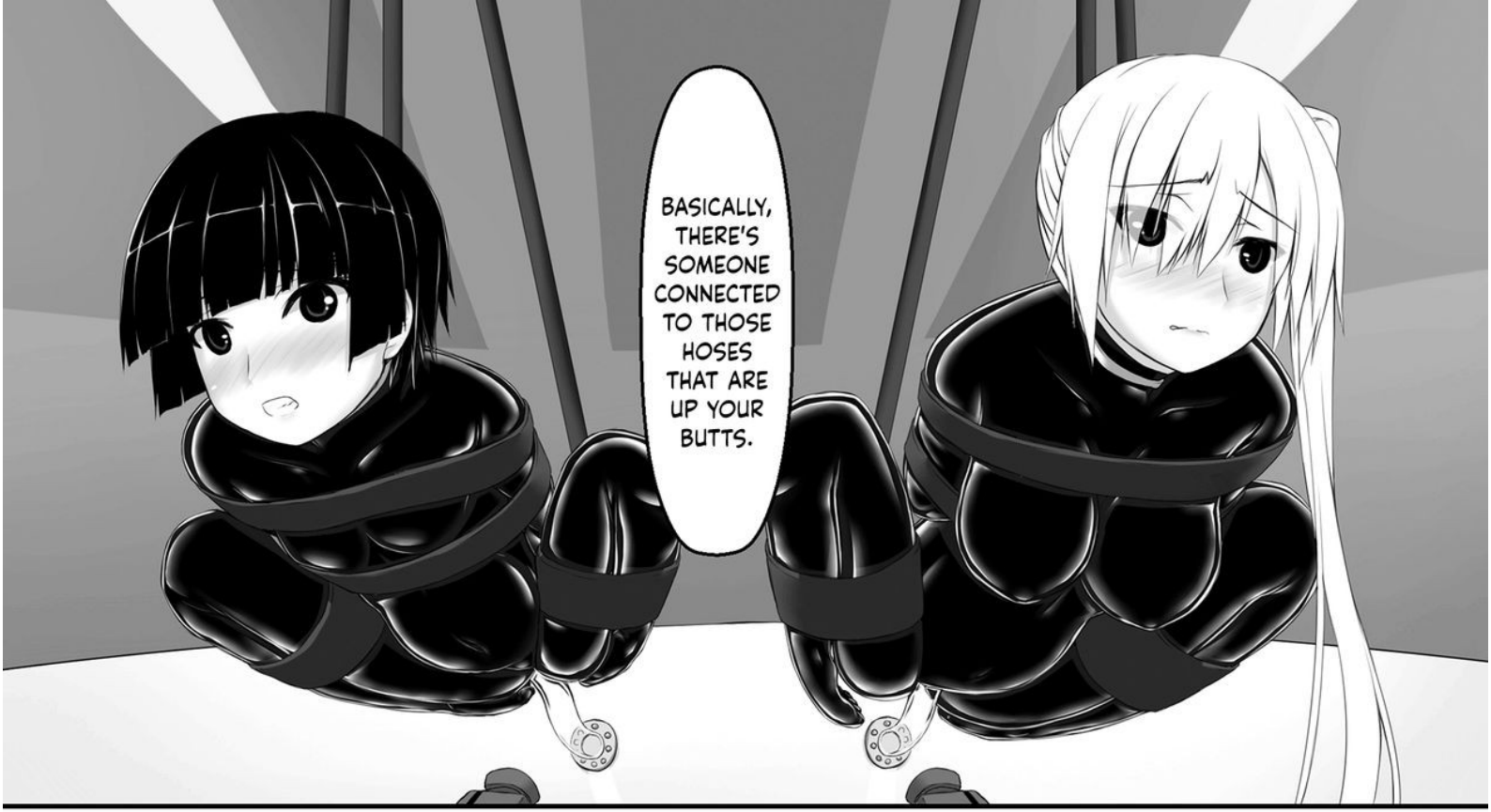

BASICALLY,
THERE'S
SOMEONE
CONNECTED
TO THOSE
HOSES
THAT ARE
UP YOUR
BUTTS.



NO
WAY...

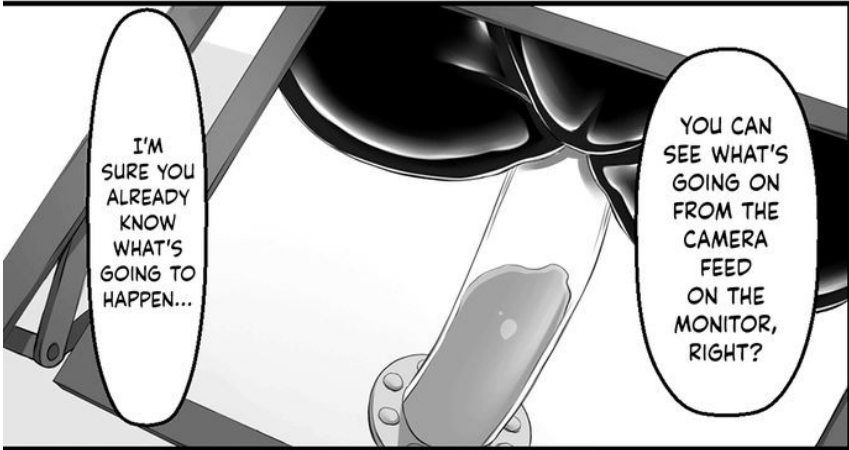
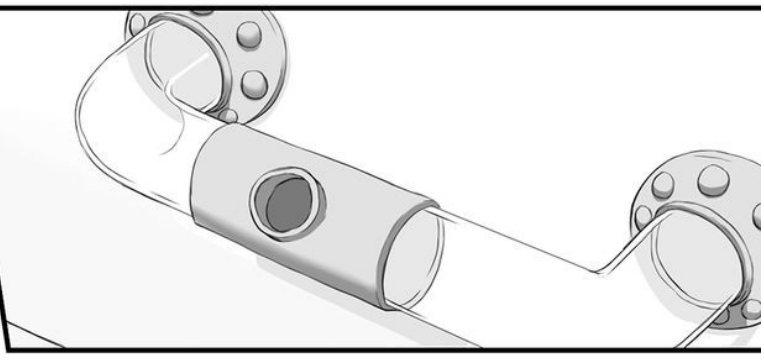

I'M
SURE YOU
ALREADY
KNOW
WHAT'S
GOING TO
HAPPEN...

YOU CAN
SEE WHAT'S
GOING ON
FROM THE
CAMERA
FEED
ON THE
MONITOR,
RIGHT?

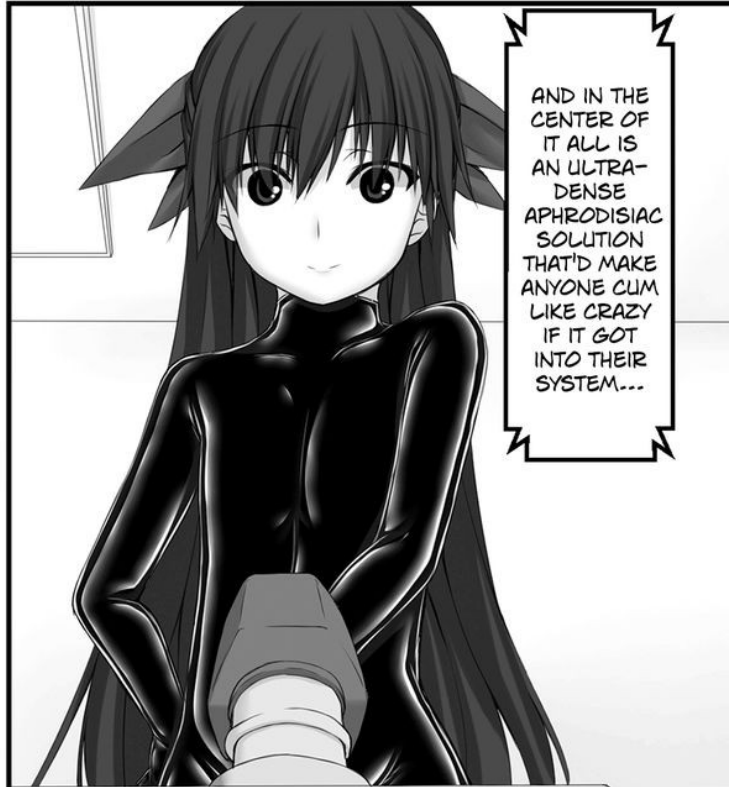

AND IN THE
CENTER OF
IT ALL IS
AN ULTRA-
DENSE
APHRODISIAC
SOLUTION
THAT'D MAKE
ANYONE CUM
LIKE CRAZY
IF IT GOT
INTO THEIR
SYSTEM...



YOU TWO ARE
GOING TO
MAKE THE
PEOPLE ON
THE OTHER
SIDE OF THE
WALL CUM
LIKE CRAZY
WITH THE
STUFF INSIDE
YOU.

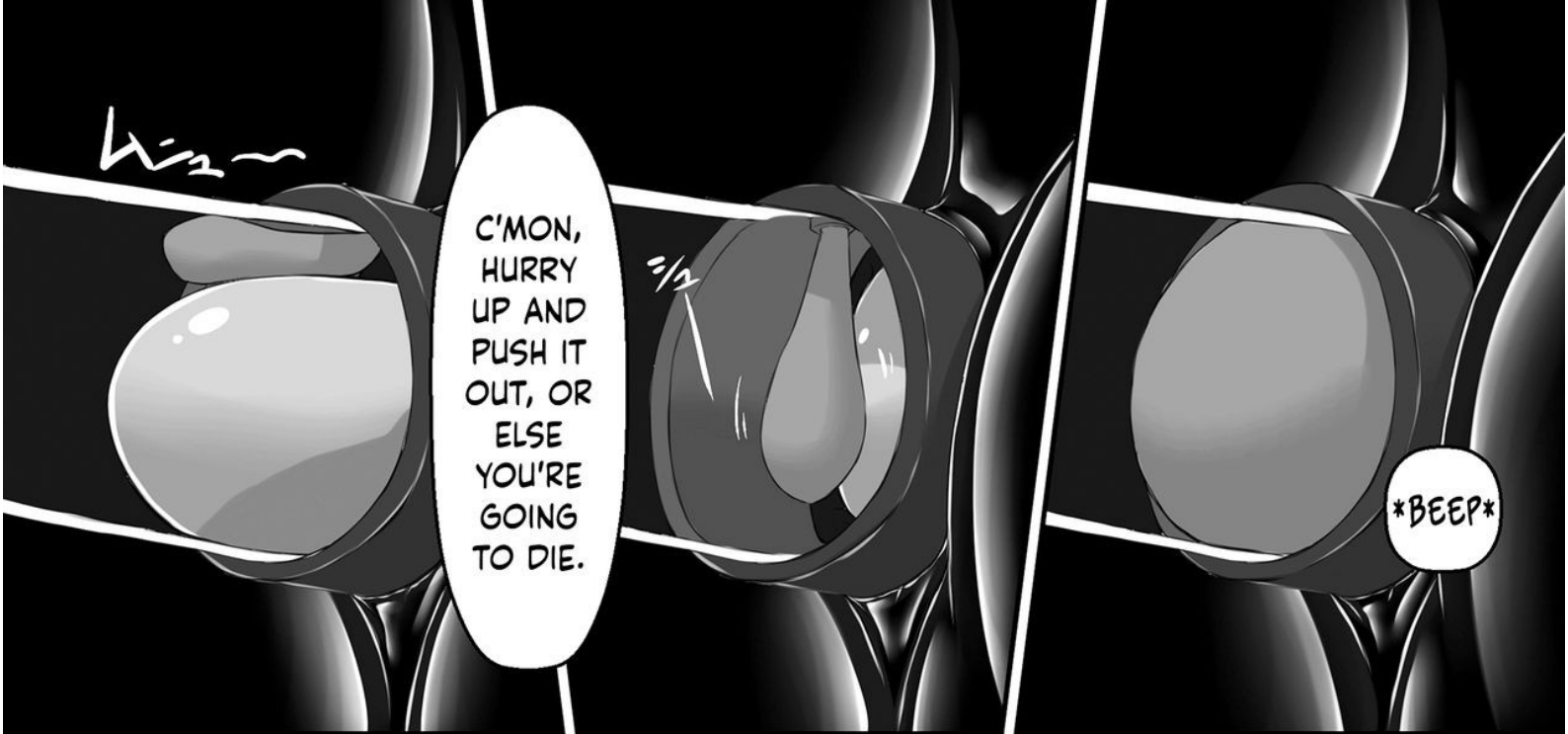

C'MON,
HURRY
UP AND
PUSH IT
OUT, OR
ELSE
YOU'RE
GOING
TO DIE.

BEEP



UUUH...

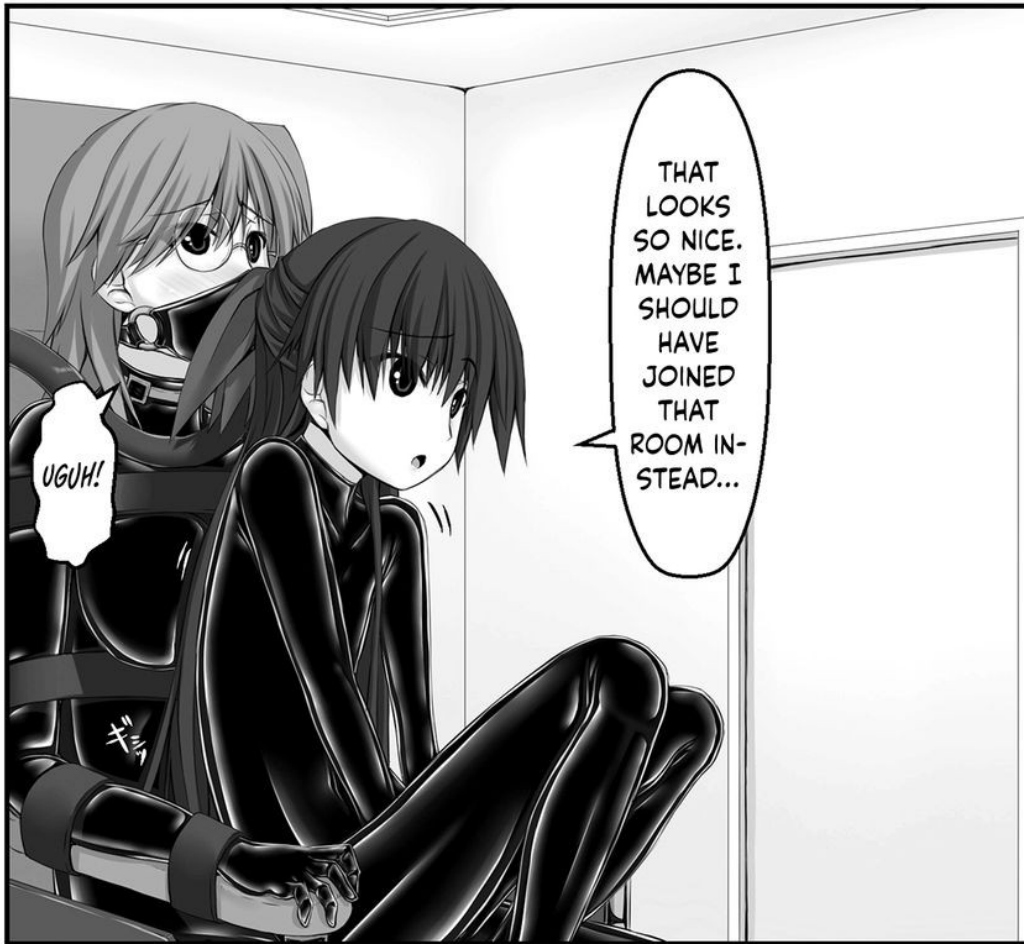

THAT
LOOKS
SO NICE.
MAYBE I
SHOULD
HAVE
JOINED
THAT
ROOM IN-
STEAD...

UGUH!



WELL, I
GUESS IT'S
FINE. WE
SHOULD
GET READY
OVER HERE,
TOO.

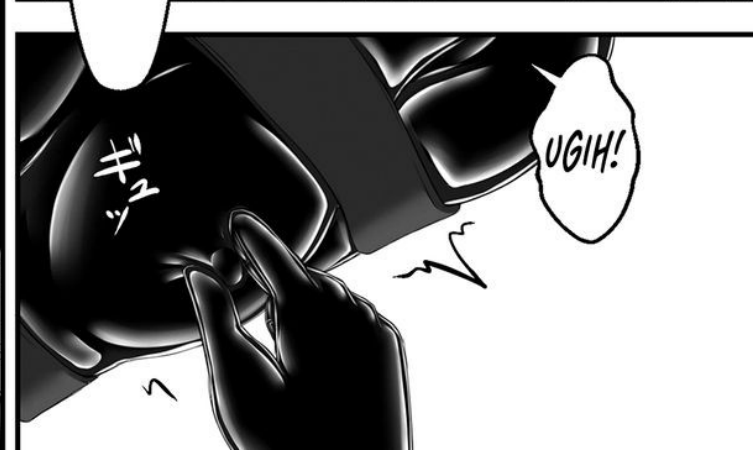

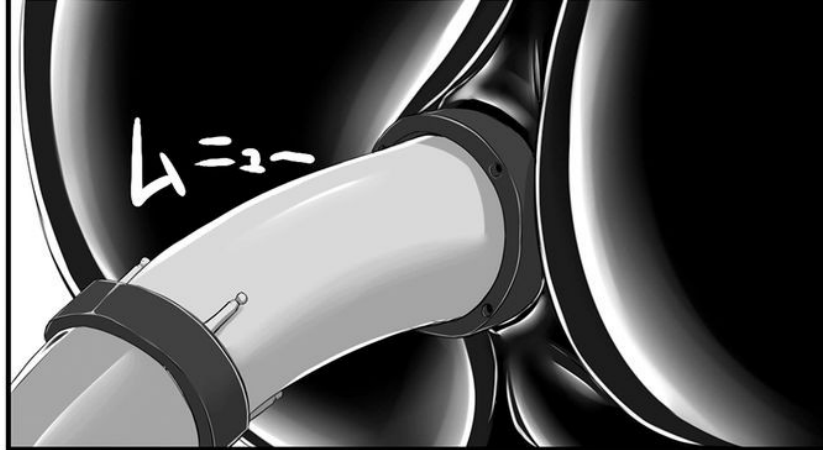

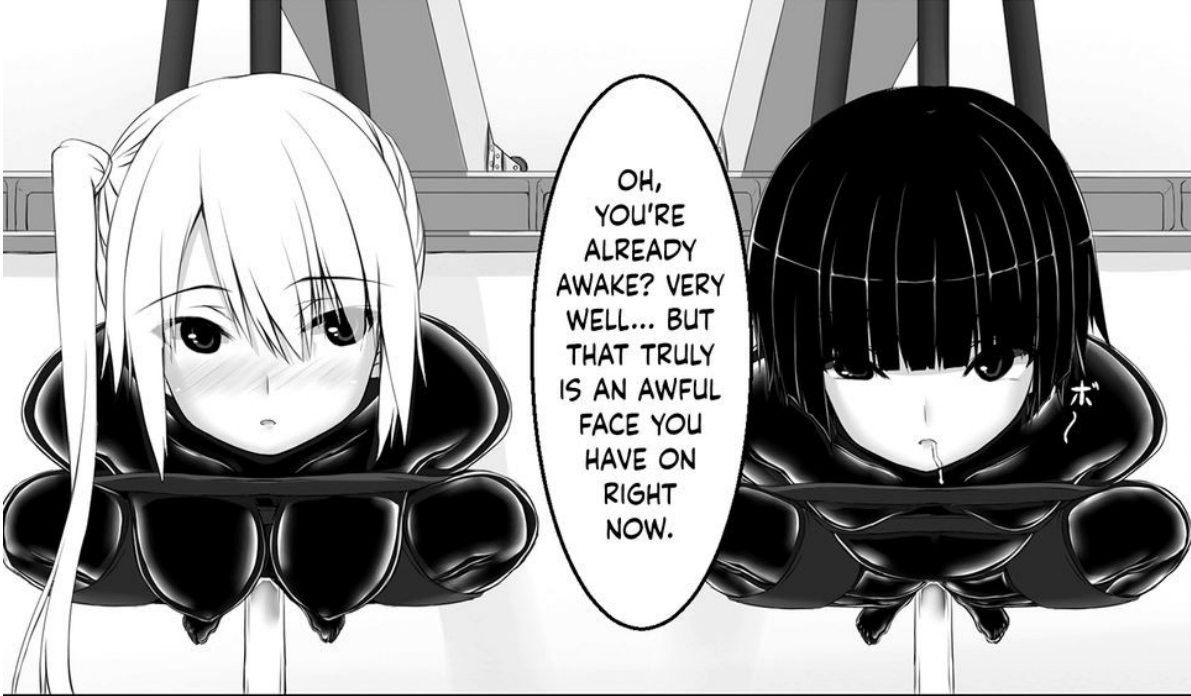

OH, YOU'RE ALREADY AWAKE? VERY WELL... BUT THAT TRULY IS AN AWFUL FACE YOU HAVE ON RIGHT NOW.



AH...!



YOU BITCH...

QUIET. THEY'RE WAITING FOR YOU ON THE OTHER SIDE OF THE WALL...

LOOK, THEY'RE HERE.





WHY THE HELL ARE YOU CAPTURED...?

WHY...?



YOU UP FOR IT? OR NOT?



WE'RE ABOUT TO BEGIN THE SAME CONTEST WE DID WITH YOU GIRLS WITH THE PERSON WHO SOLD YOU!



I'LL
MURDER
YOU!

I WON'T
FORGIVE
YOU... I
WON'T
FORGIVE
YOU NO
MATTER
WHAT...

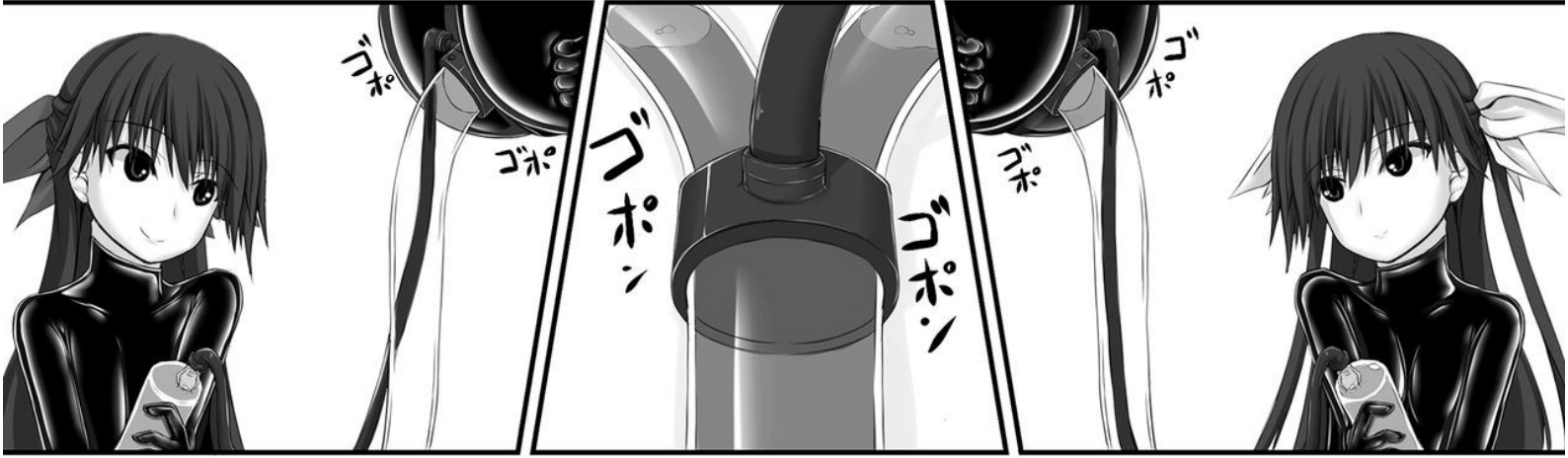

ゴポ

ゴポ

ゴポッ

ゴポッ

ゴポ

ゴポ

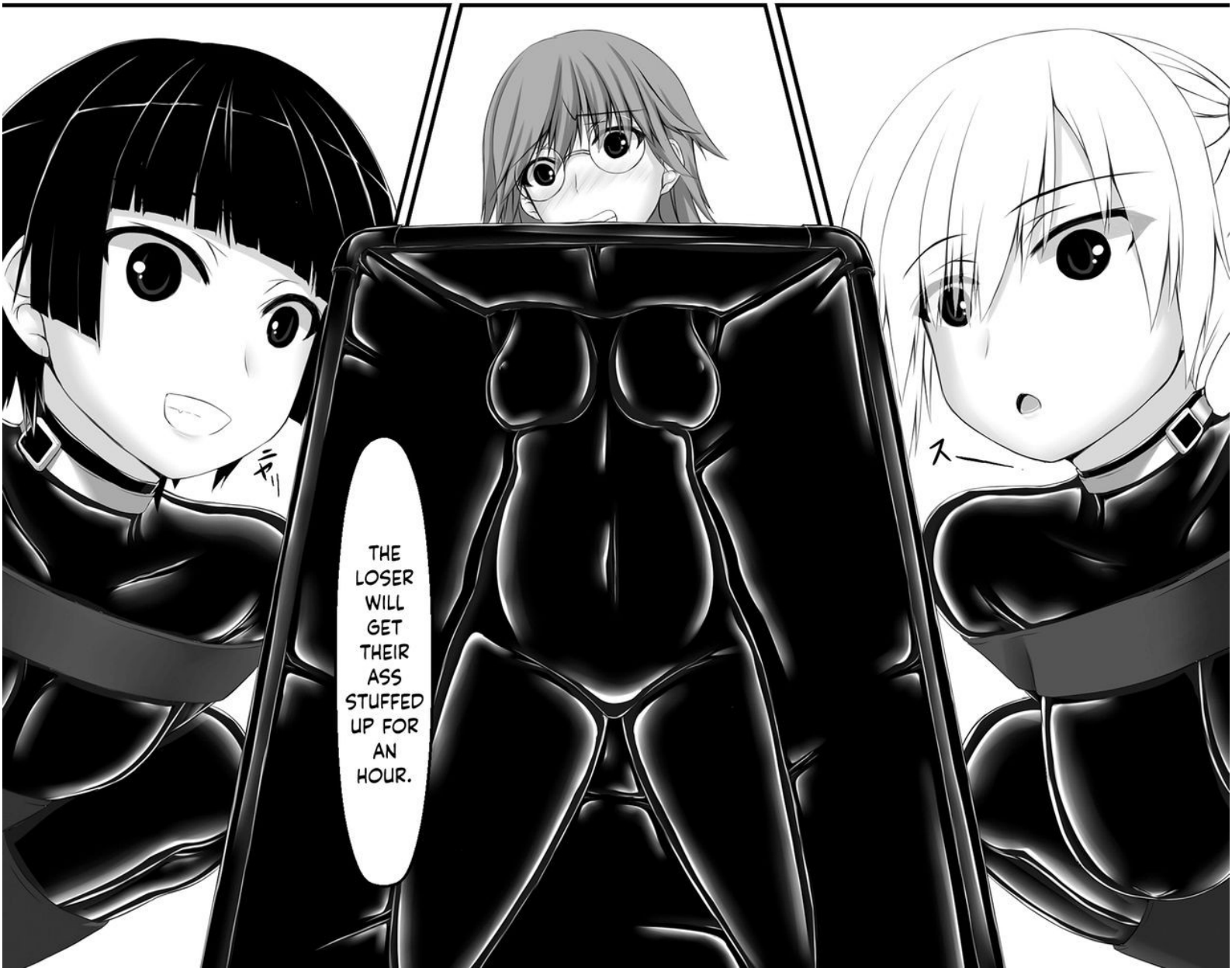

THE
LOSER
WILL
GET
THEIR
ASS
STUFFED
UP FOR
AN
HOUR.

ス

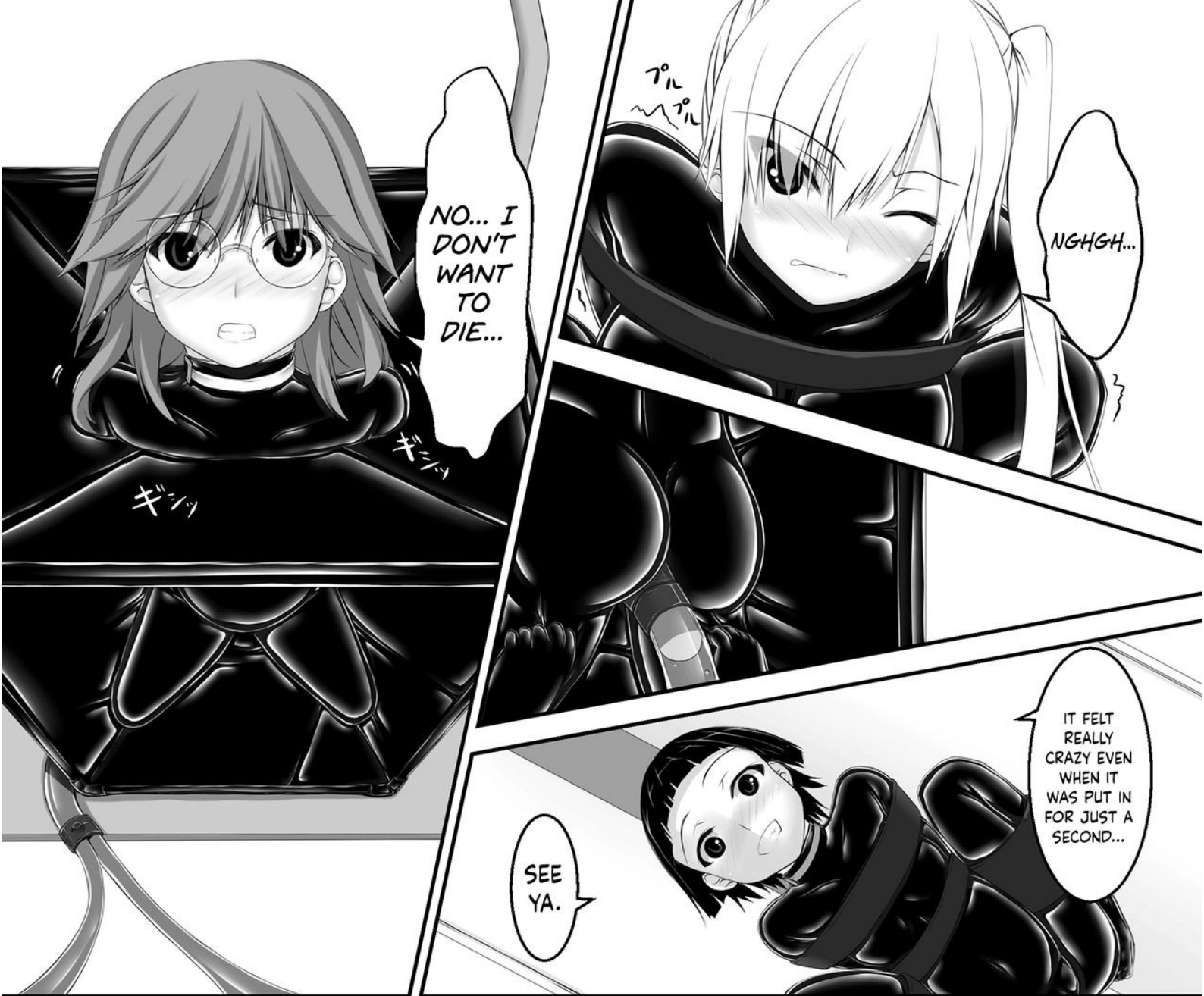

NO... I DON'T WANT TO DIE...

NGHGH...

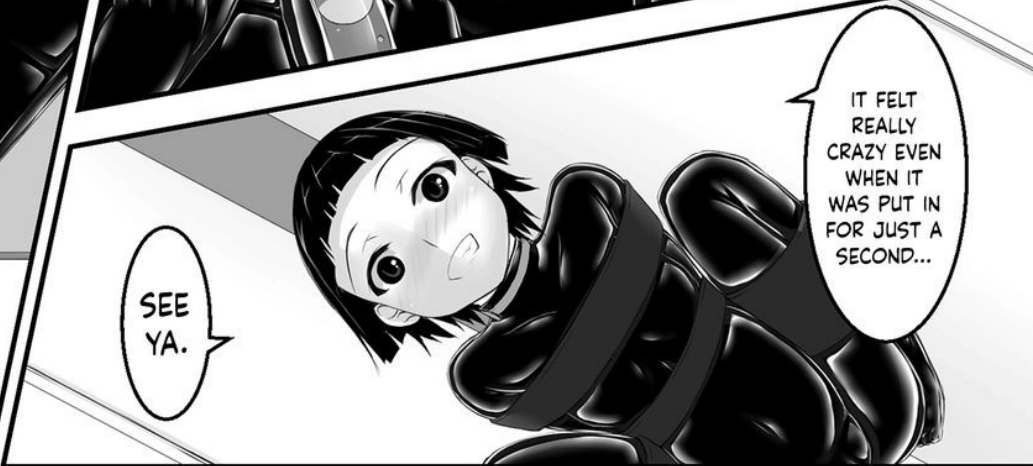

SEE YA.

IT FELT REALLY CRAZY EVEN WHEN IT WAS PUT IN FOR JUST A SECOND...



FUFU~ HOW HORRIBLE...

MMM...

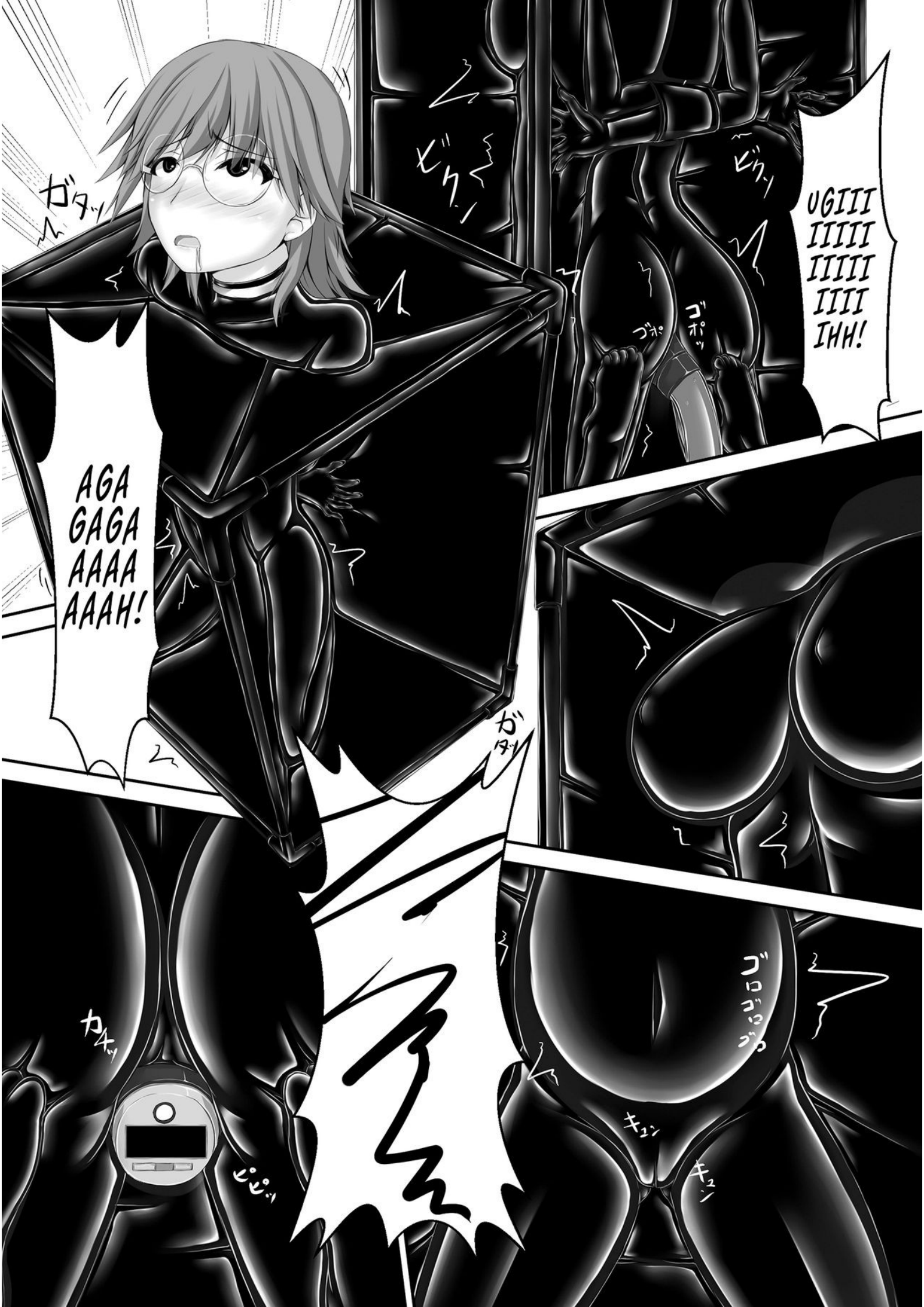

ガッ

ウググ

ウググ
ウググ
ウググ
ウググ
ウググ

AGA
GAGA
AAAA
AAAH!

2

ガッ

アハハ

ガッ



ウググ

ウググ

ウググ

ウググ



I SEE...
THANK YOU,
WE'LL GIVE
YOU THE
MONEY
DIRECTLY.

AS
ORDERED,
WE'VE
COLLECTED
THE DATA.
THE THREE
OF THEM
ALL MEET
THE
NECESSARY
REQUIRE-
MENTS...



WHAT
ARE YOU
DOING,
LET ME
GO!

HUH...?



Can I
get on
top?

No
can
do.



WELL,
IT'S FIVE
PEOPLE
ACTUALLY.

TRY NOT
TO ORDER
THREE
PEOPLE
AT ONCE
ANYMORE.



あとがき

初めましてしょーやんと申します。

お久しぶりです。しょーやんです。

今回はBeginningblackの5作目になります。久しぶりのコミケということもあり

自分なりに濃い内容のモノにしてみました。

テーマは「裏切り」です。

それもあって表紙はいつもは責められるキャラなのですが責める側のキャラを描きました。

内容に関しては引く人もおられるかなと思い描くのを渋っていたのですが

今更だなと思い切って描きました。

フレイの内容に関しては自分で考えたものではなく詳しくは

「アナルゼリー相撲」で検索していただければなど

というの・・・最近ぴっちりものの漫画ばかり描いていて他のイラストをあまり描けていない

状況でして需要はないかもしれませんがつぎは久々にイラスト本を作ろうかなと思っております。

Pixiv、Twitter、DLsiteなどのレビューやコメントなどありがとうございます！

自分が描きたいものもふわふわしていますが今後とも妄想美術部を見ていただければ嬉しいです。

Pixiv:id=1305905

Twitter : @puringaoisiyo

連絡先 : お手数ですがTwitter、PixivのDMにてよろしくお願いします。

発行 : 妄想美術部

発行者 : しょーやん

発行日 : 2019/08/11

印刷所 : オレンジ工房様

ダウンロード販売 : DLsite様

https://www.dlsite.com/maniiax/circle/profile/=/maker_id/RG23510.html

**Visit Hennojin at
www.hennojin.com**

**Support us on Patreon at
www.patreon.com/hj2**



**Commissioner: BlueRaz
Translator: Potato
Editor: Baran
Proofreader: Vilis**