

Shishunki Medical

Kodama Naoko

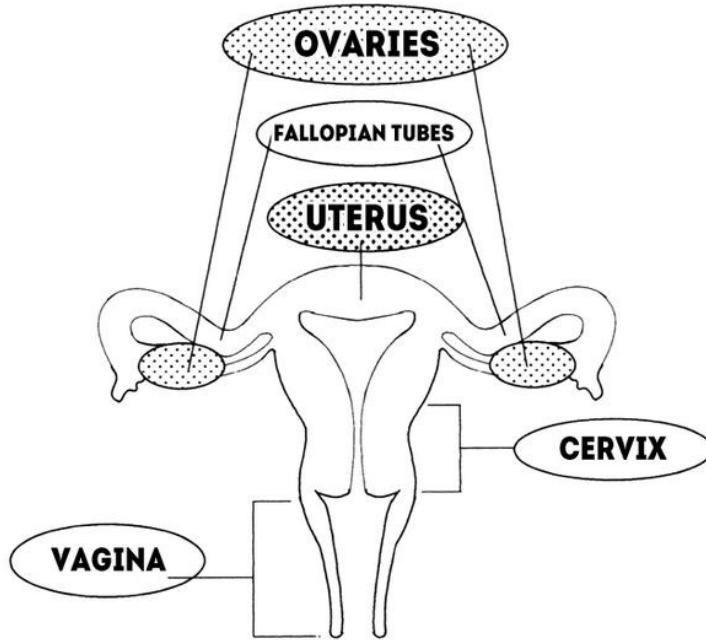

SEX EDUCATION IS SUPER INTERESTING, LIKE WHEN THEY SHOW US THOSE VIDEOS.



I ALMOST ALWAYS SLEEP THROUGH CLASS, BUT FOR TODAY'S HEALTH AND PHYSICAL EDUCATION, I WAS WIDE AWAKE.

Glance



Ovulation is...

...of the menstrual cycle...

AND "SEX IS SOMETHING SACRED, IT ISN'T DIRTY."

STUFF LIKE "THE ATTRACTION BETWEEN MEN AND WOMEN IS AN INSTINCTUAL DRIVE TO PROCREATE,"

FERTILIZATION, CONTRACEPTION, SEXUALLY TRANSMITTED DISEASE, ALL THAT.



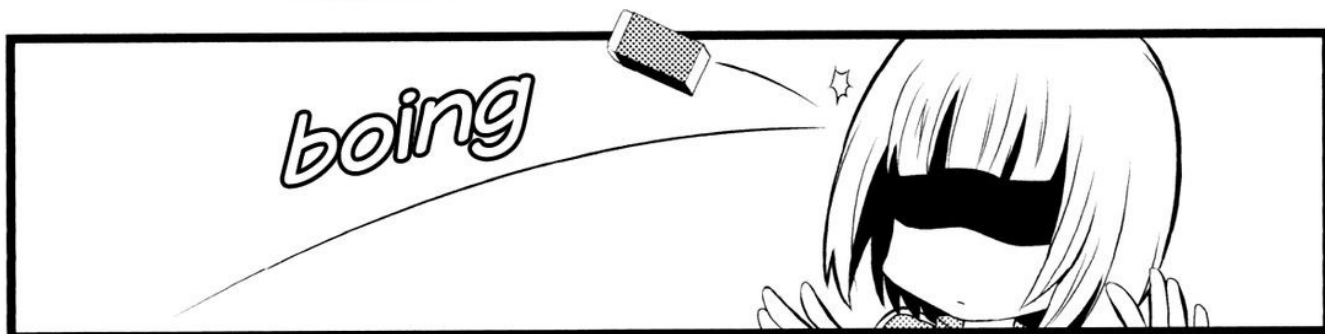
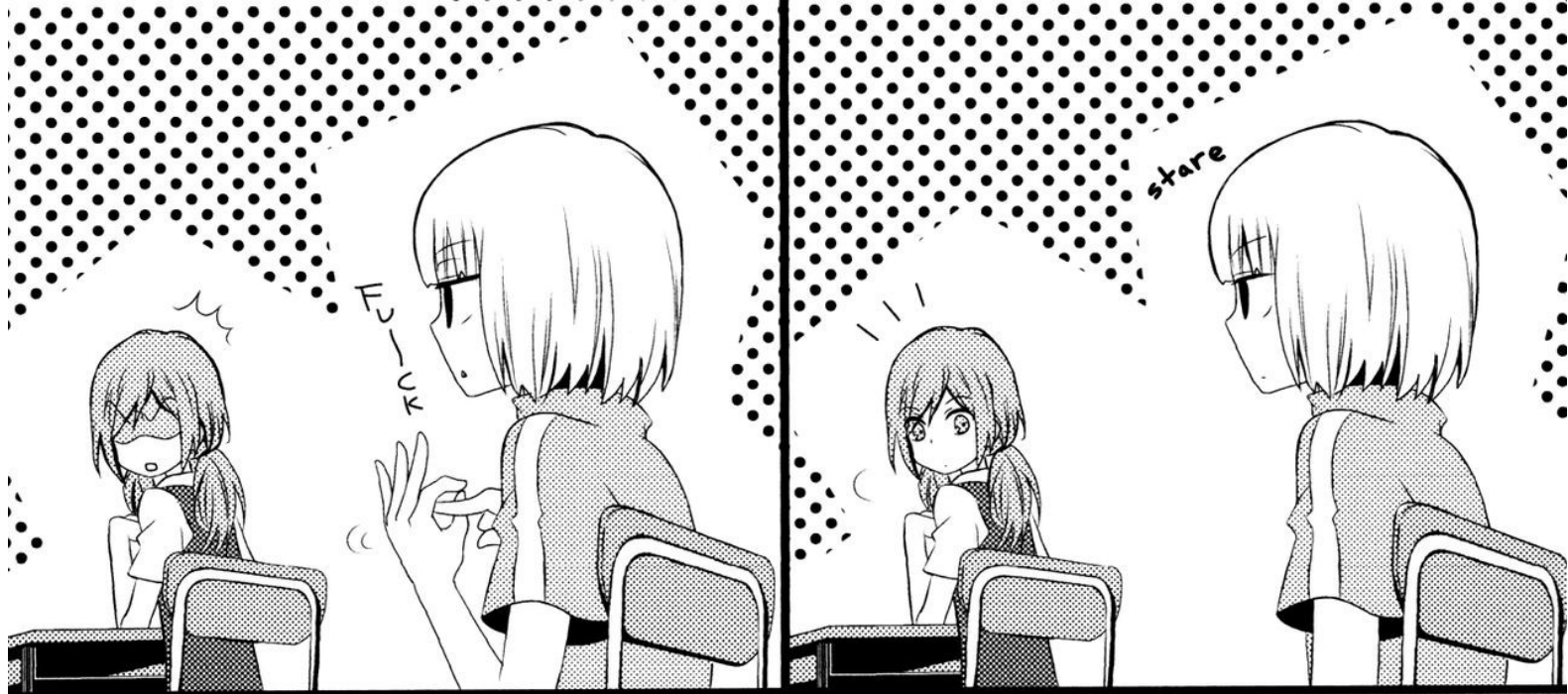

AT THE
END OF CLASS,
CONDOMS WERE
DISTRIBUTED
TO EVERYONE.

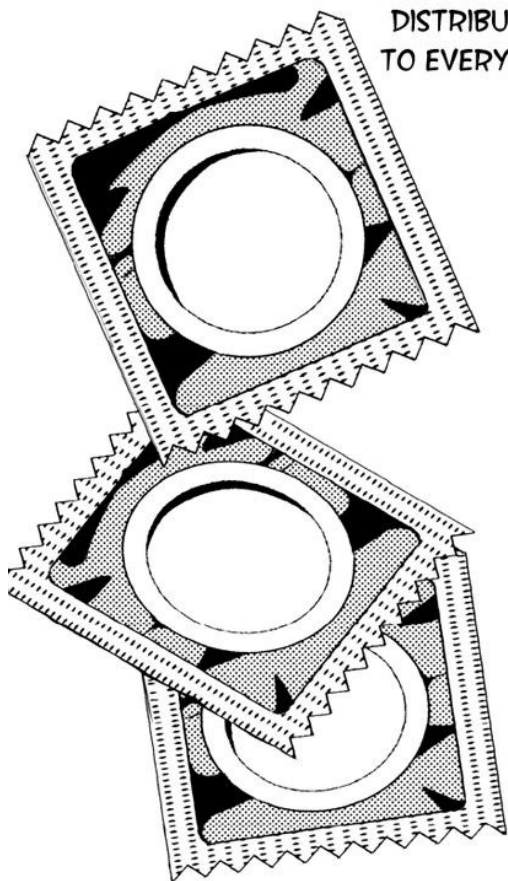

SLAP

BLOW

HLUH?
C'MON,

IT'S NOT
LIKE WE
NEED
THESE
THINGS.

!

WHAT ARE
YOU DOING,
SHUKIKO!
YOU IDIOT!

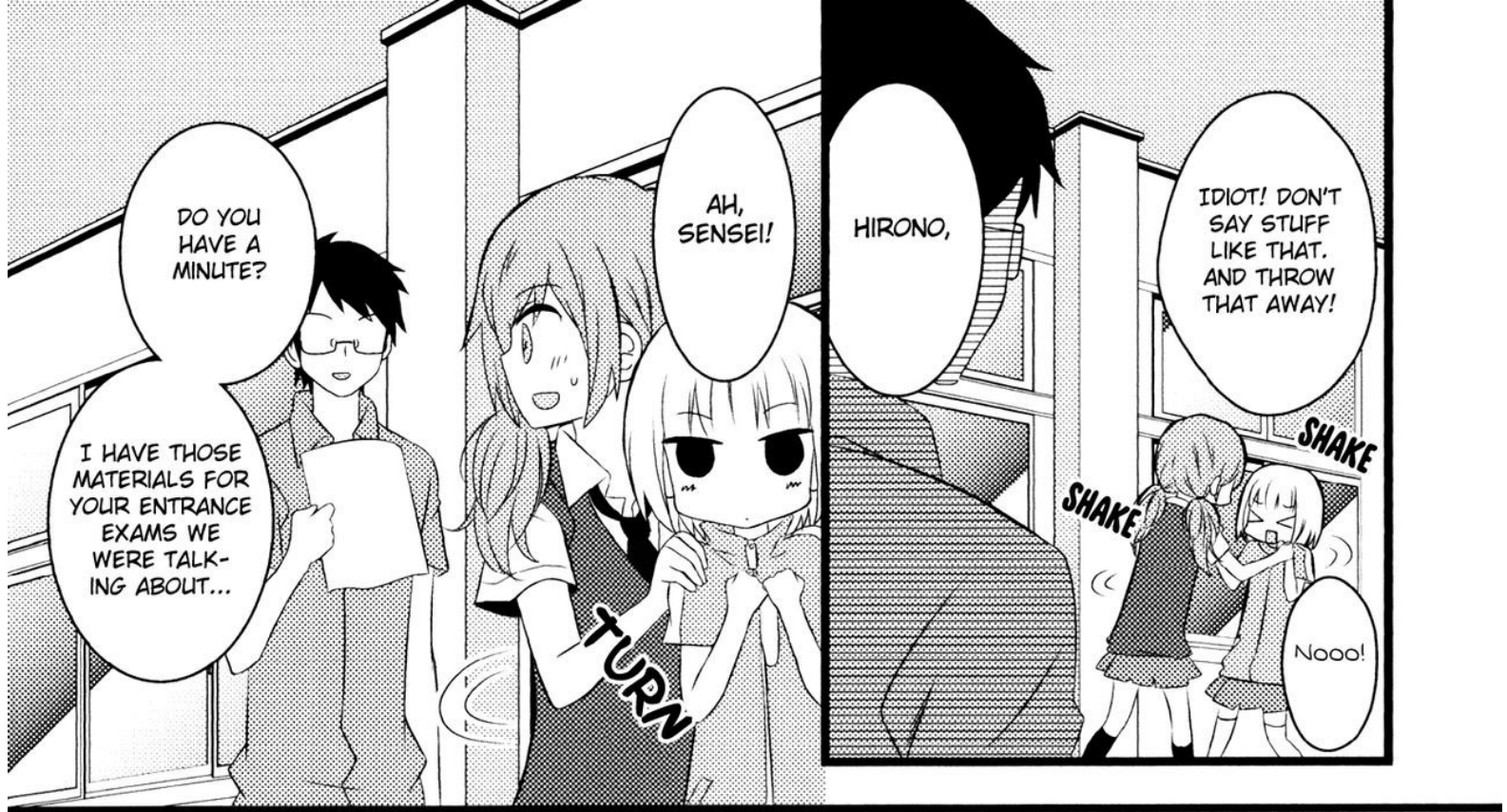

DO YOU HAVE A MINUTE?

I HAVE THOSE MATERIALS FOR YOUR ENTRANCE EXAMS WE WERE TALKING ABOUT...

AH, SENSEI!

HIRONO,

IDIOT! DON'T SAY STUFF LIKE THAT. AND THROW THAT AWAY!

TURN

SHAKE

Nooo!

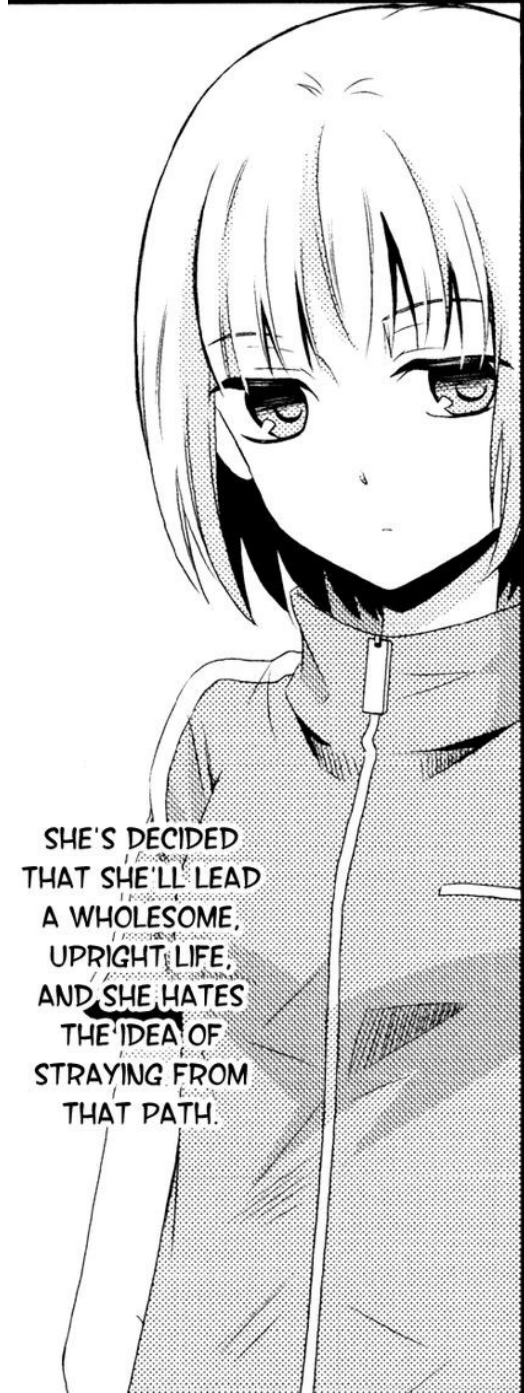

SHE'S DECIDED THAT SHE'LL LEAD A WHOLESOME, UPRIGHT LIFE, AND SHE HATES THE IDEA OF STRAYING FROM THAT PATH.



SHE'S DECIDED WHICH UNIVERSITY SHE WANTS TO GO TO, WHAT PROFESSIONAL QUALIFICATIONS SHE'S GOING TO GET, AND SHE'S STUDYING IN PREPARATION.

KIKU ALREADY KNOWS EXACTLY WHAT SHE WANTS TO DO IN THE FUTURE.



I REALLY THINK K UNIVERSITY WOULD BE BEST.

OH, THANK YOU!

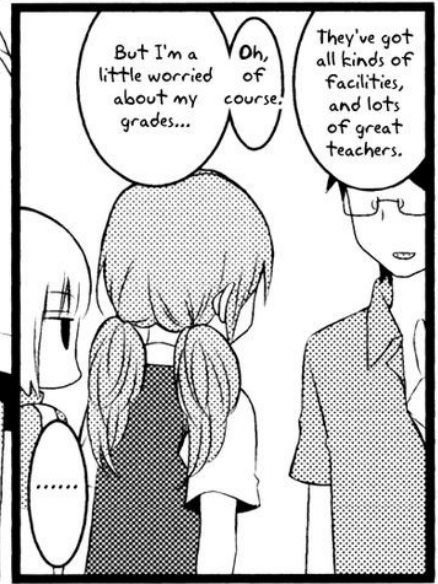

But I'm a little worried about my grades...

Oh, of course.

They've got all kinds of facilities, and lots of great teachers.

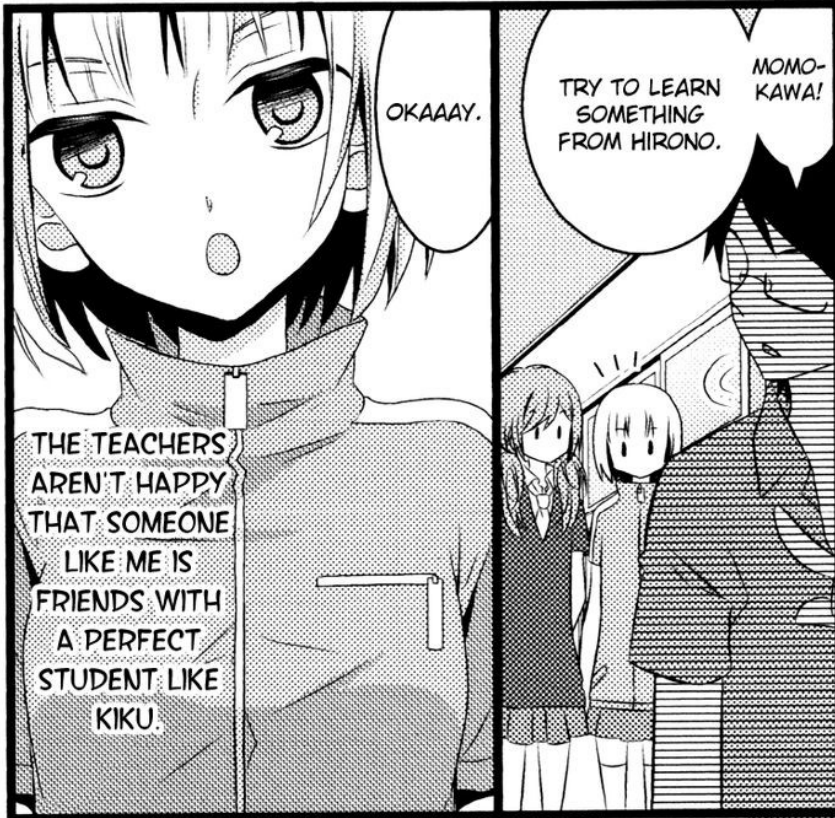

OKAAAY.

TRY TO LEARN
SOMETHING
FROM HIRONO.

MOMO-
KAWA!

THE TEACHERS
AREN'T HAPPY
THAT SOMEONE
LIKE ME IS
FRIENDS WITH
A PERFECT
STUDENT LIKE
KIKU.



TRYING TO
THINK THAT
FAR AHEAD
GIVES ME A
HEADACHE.

ON THE
OTHER
HAND,
I DON'T
HAVE ANY
PLANS
AT ALL.



I'M HER
GIRLFRIEND.

BUT THE
TRUTH IS



THERE WAS A REPORT DUE?

松永

DID YOU NOT TURN IN THE REPORT ON THE READING?

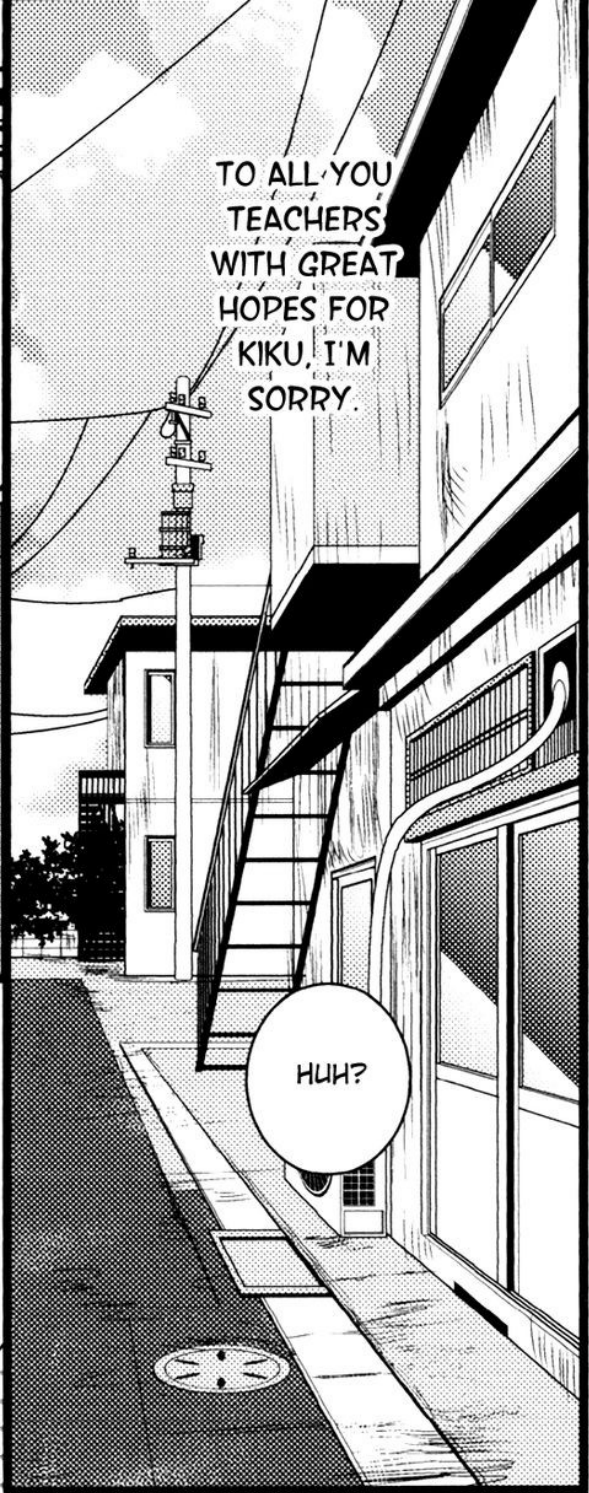

TO ALL YOU TEACHERS WITH GREAT HOPES FOR KIKU, I'M SORRY.

HUH?

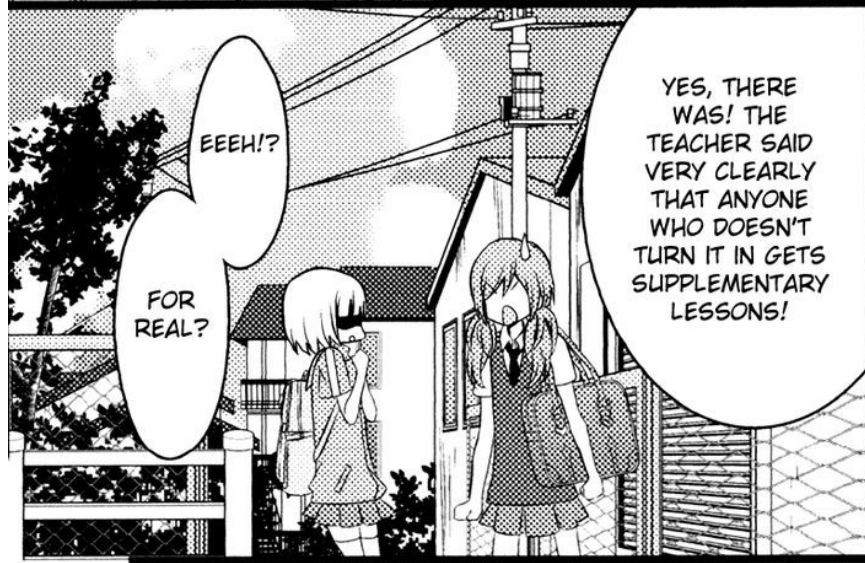

FOR REAL?

EEEH!?

YES, THERE WAS! THE TEACHER SAID VERY CLEARLY THAT ANYONE WHO DOESN'T TURN IT IN GETS SUPPLEMENTARY LESSONS!



YOU IDIOT!



SERIOUS

I WAS AWAKE FOR HEALTH CLASS.



NOT JUST THE READING, YOU SLEEP THROUGH EVERY CLASS.



I DON'T KNOW ANYTHING ABOUT IT.

I SLEPT THROUGH THE READING.

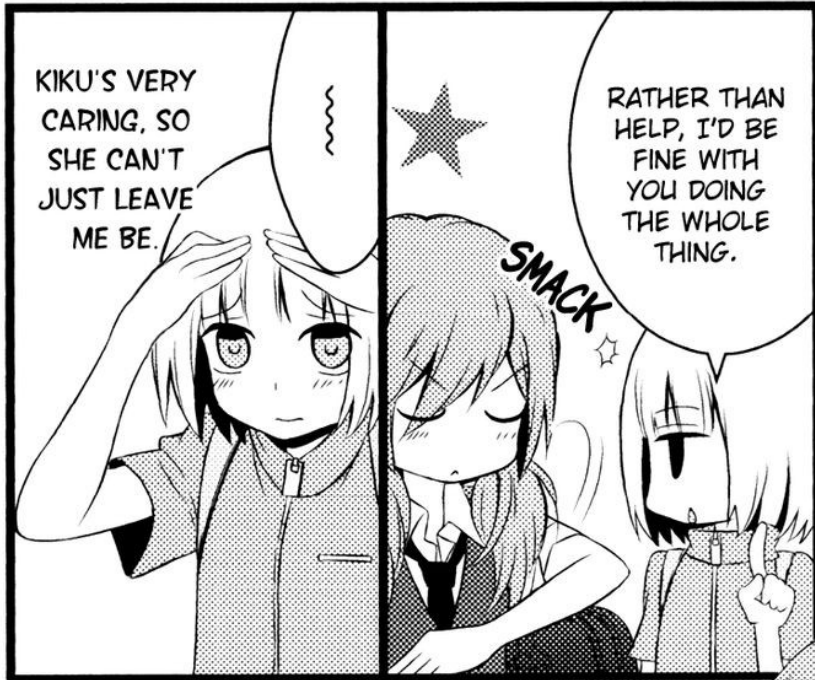

KIKU'S VERY CARING, SO SHE CAN'T JUST LEAVE ME BE.

RATHER THAN HELP, I'D BE FINE WITH YOU DOING THE WHOLE THING.

SMACK



DO THE ASSIGNMENT RIGHT NOW.

I'LL HELP YOU.



I'LL DEMAND A FITTING REWARD.

EEEH?



I MAKE USE OF THAT PART OF HER AND FOOL AROUND AS MUCH AS I WANT, CAUSING HER A LOT OF TROUBLE.

DON'T BE NAIVE!

MY HELP DOESN'T COME FOR FREE!

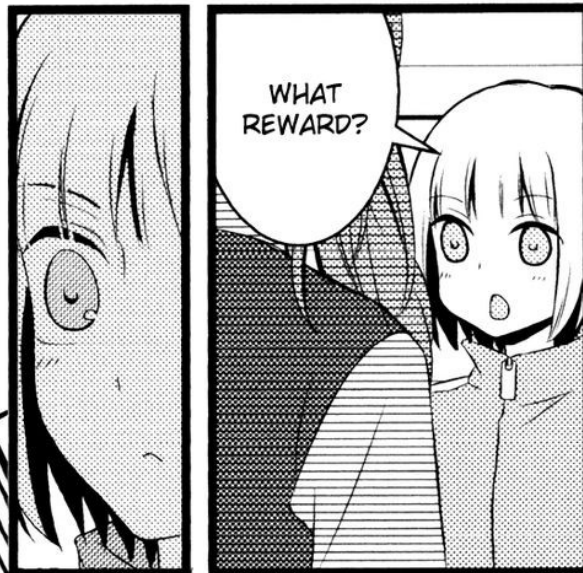

WHAT REWARD?



... I'LL
HELP YOU
WITH THE
ASSIGMENT,





LET'S GO.

.....

SO COME TO MY PLACE.



THAT'S HER REWARD?

KIKU'S A JERK.

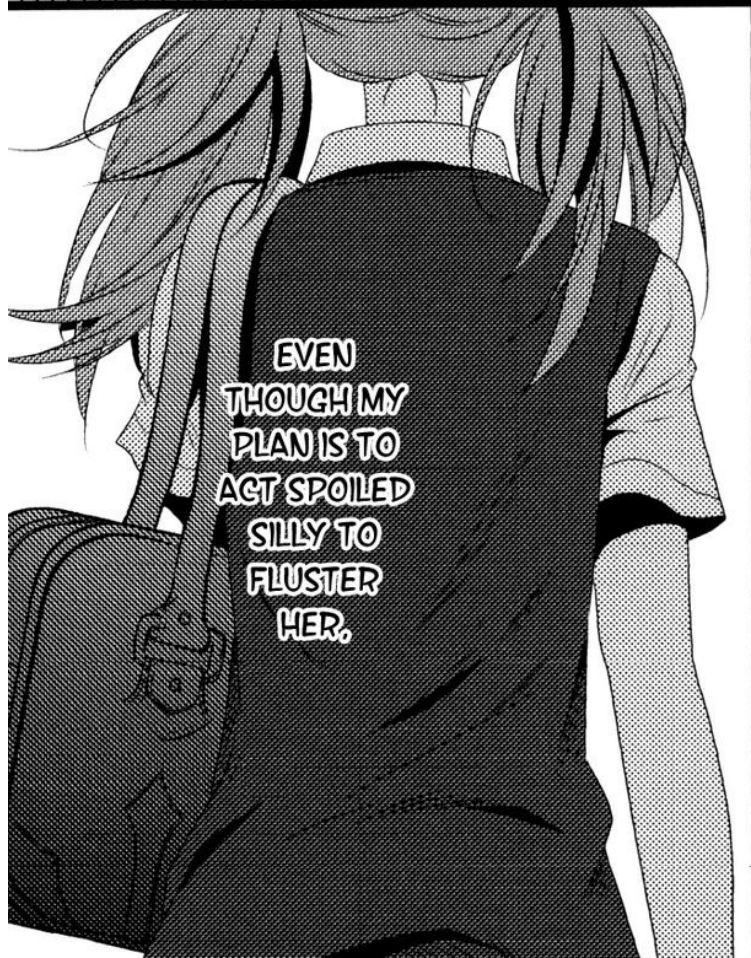

EVEN THOUGH MY PLAN IS TO ACT SPOILED SILLY TO FLUSTER HER.



HOLD



SHE ALWAYS
TURNS IT
AROUND ON
ME IN AN
INSTANT.

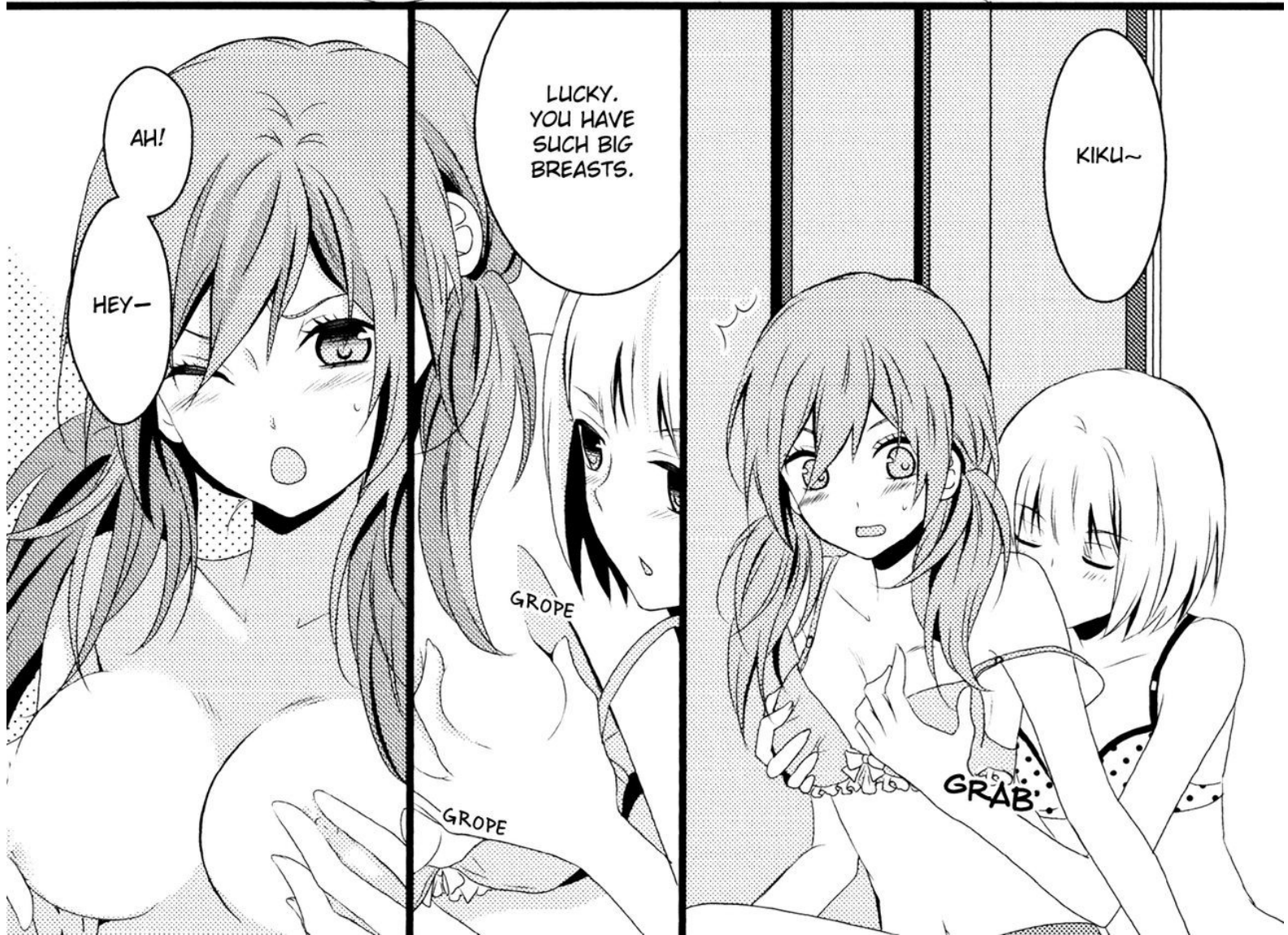

AH!

HEY—

LUCKY.
YOU HAVE
SUCH BIG
BREASTS.

KIKU~

GROPE

GROPE

GRAB



AHN

AH

TWITCH

SLIP

RUSTLE

LOOKS LIKE WE BOTH ARE.

KIKU-CHAN, YOU'RE SO DIRTY~

SHE'S GOT
HER FUTURE
PLANS ALL
FIGURED OUT.

KIKU HATES
WASTING TIME.

I SEEM LIKE A
ROUGH AND
THOUGHTLESS
IDIOT,

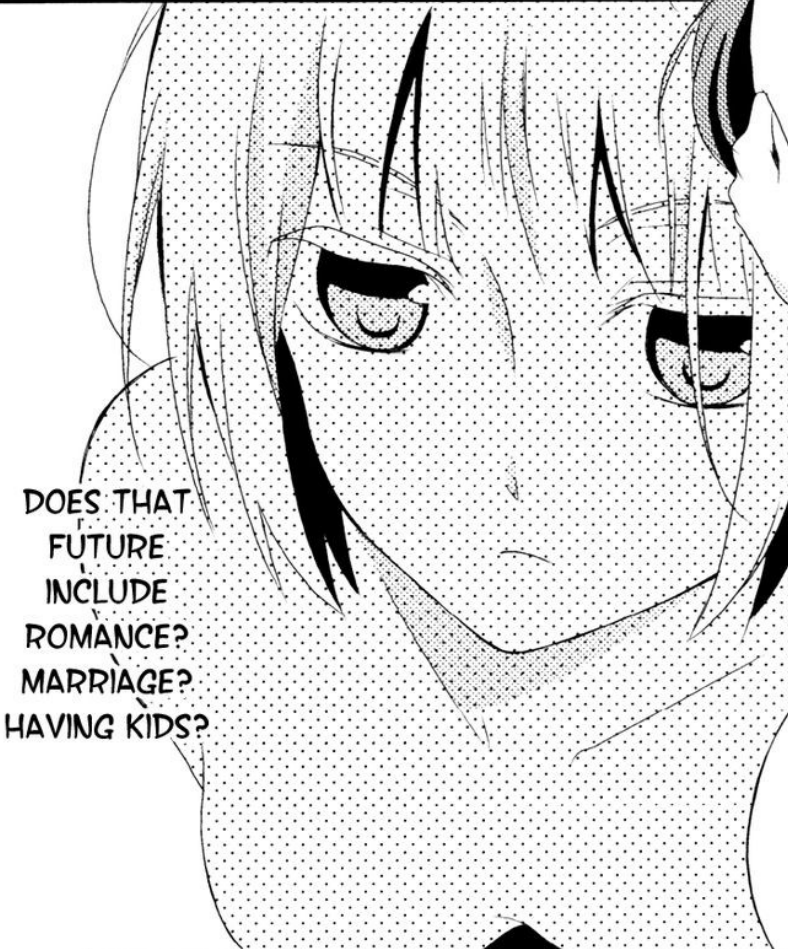
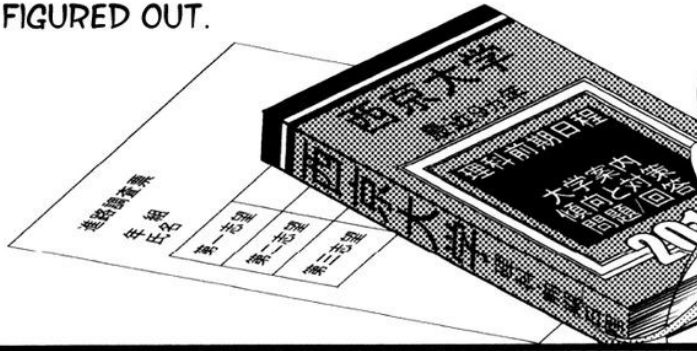

DOES THAT
FUTURE
INCLUDE
ROMANCE?
MARRIAGE?
HAVING KIDS?

BUT THERE'S
SOMETHING
I'M TOO
AFRAID TO
ASK KIKU.



EH?

WAIT—



PUSH

MN—

SHUDDER

"THE ATTRACTION BETWEEN MEN AND WOMEN
IS AN INSTINCTUAL DRIVE TO PROCREATE."

INSIDE OUR BODIES IS AN ORGAN THAT EXISTS
TO CONCEIVE AND MAKE A CHILD.

THAT PLACE,
WHICH SOME
MAN MIGHT
ONE DAY
PENETRATE,

HAH

HAH

I PENETRATE
WITH MY
FINGERS AND
TONGUE, BUT
POINTLESSLY
AND WITHOUT
MEANING.

EVEN WITHOUT
CONTRACEPTION,
WE CAN'T
CONCEIVE.

EVEN THOUGH
WE'RE DATING,
WE CAN'T GET
MARRIED.

IN KIKU'S
LIFE, I'M THE
BIGGEST
WASTE.



Shishunki Medical

Kodama Naoko

Translation: schuyguy
Editing: Asukaori
Raws: WeatheredPeach
QC: Multiball

yuri-project.net

