

『揚げ物屋 あじ吉』  
店主 降谷みつ子

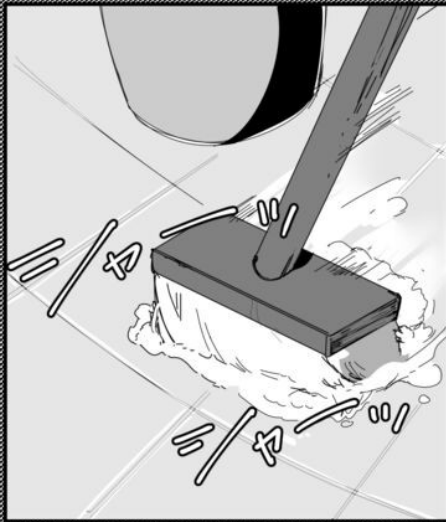







だから  
違うんだって!!

ビクン

ギョッ

ギョッ



ひっ



かあさんのことが  
女性として好きなんだ!

ギョッ  
セックス...

セックス!  
セックスしたいんだよ!



大きい...

ギョッ







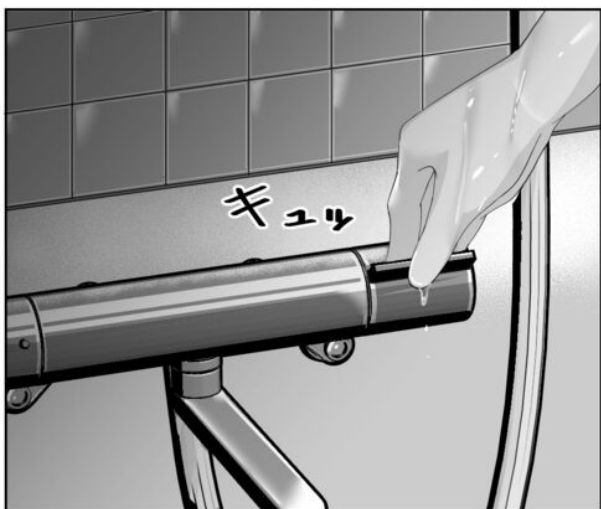



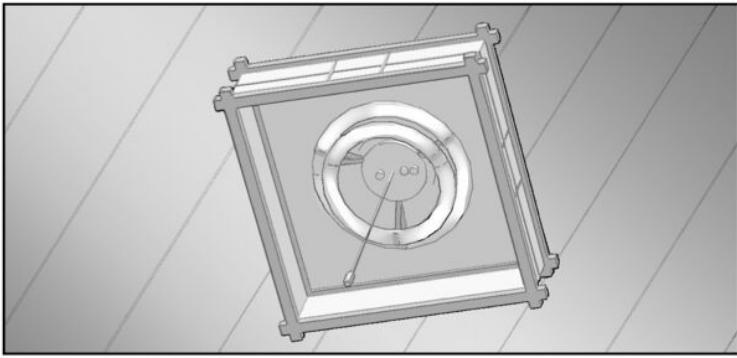



母さんが裸で  
目の前に...

どうしたの...  
やっぱりやめる?

や...やるっ!!

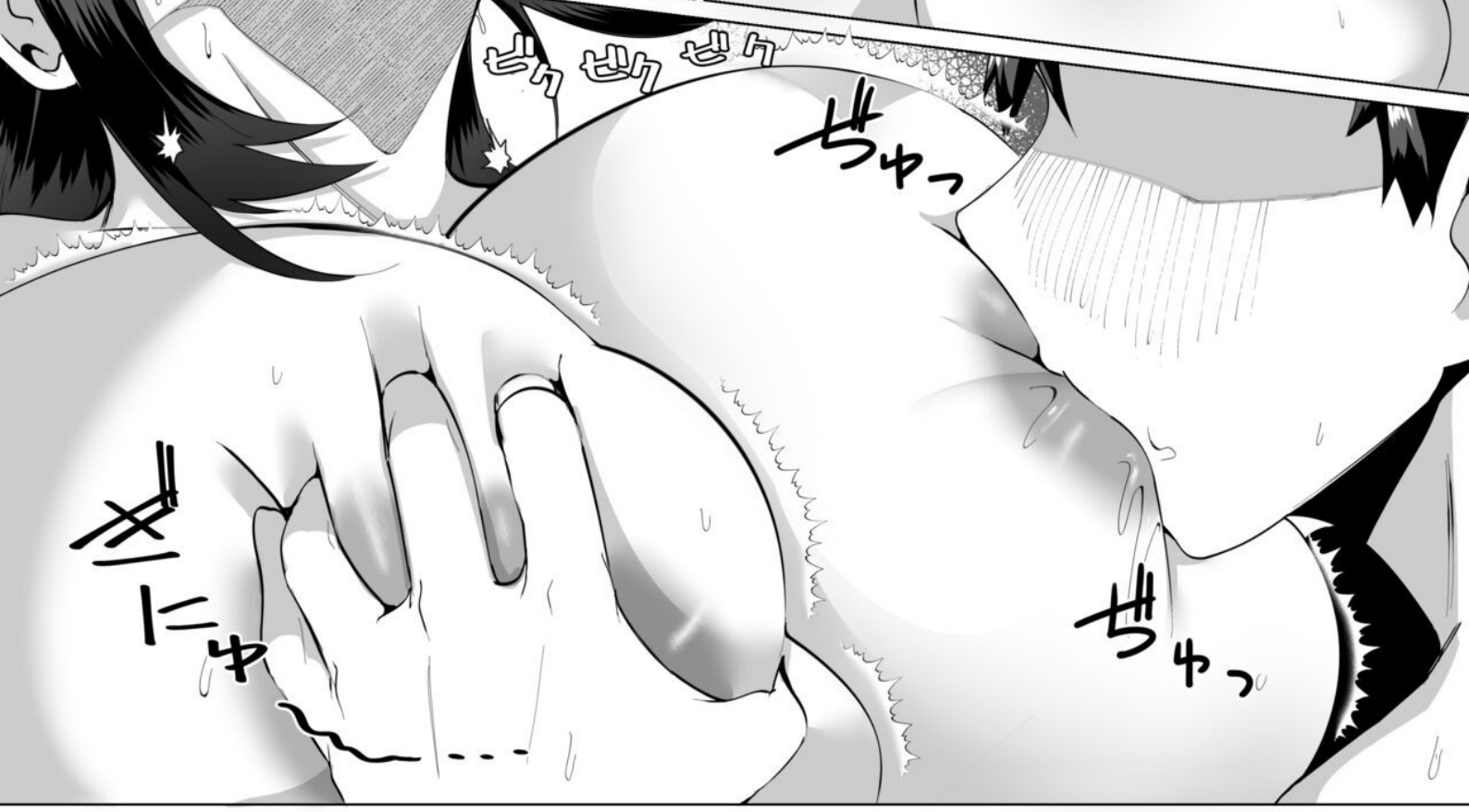



ちゅっ...

母さんのアソコ濡れてテラテラ光ってる...

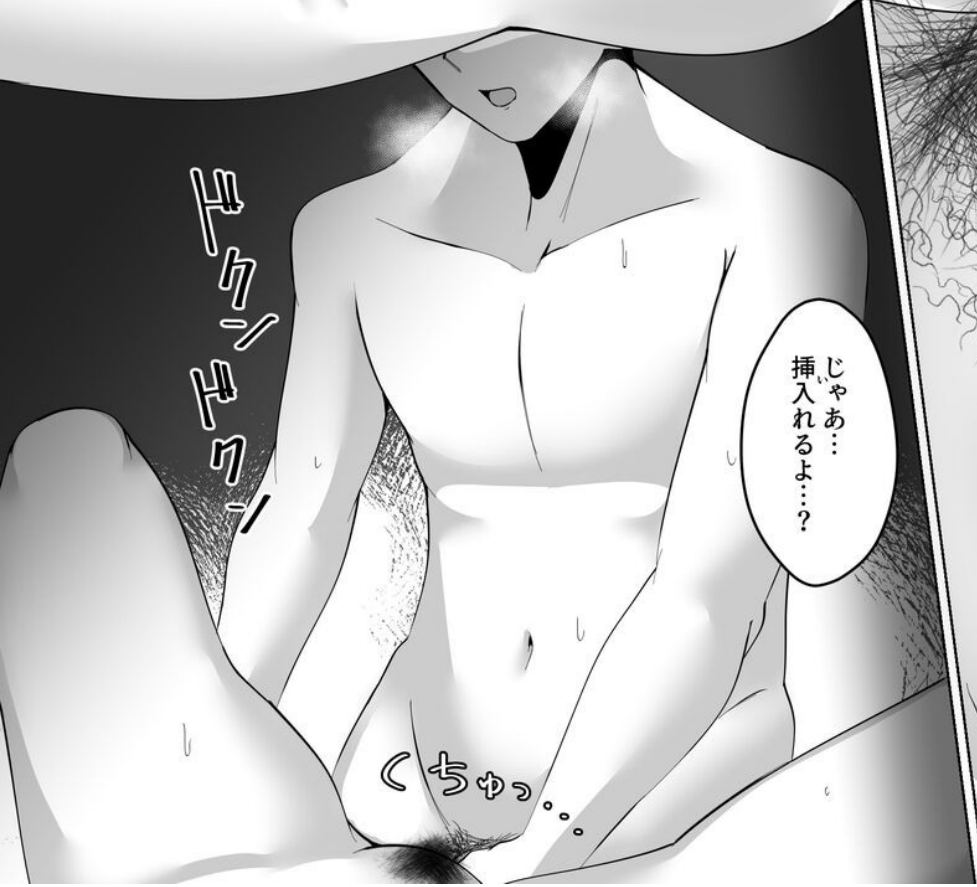

モクンモクン

じゃあ...  
挿入れるよ...?

くちゅっ...

っっ...

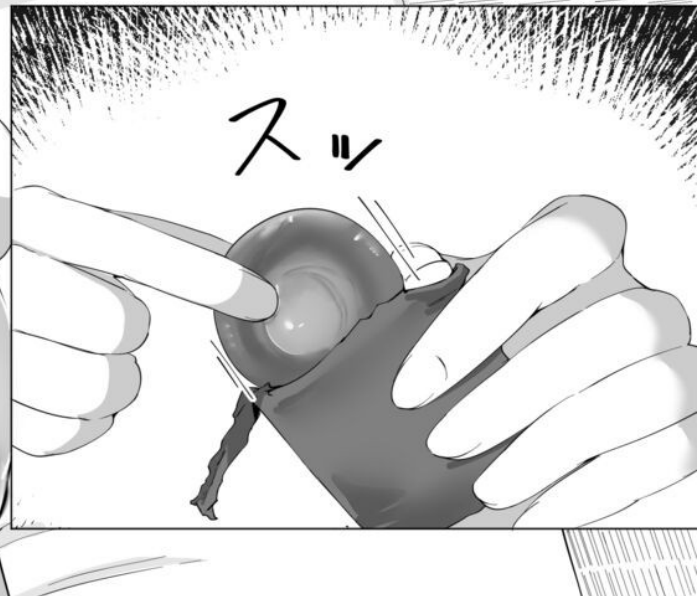
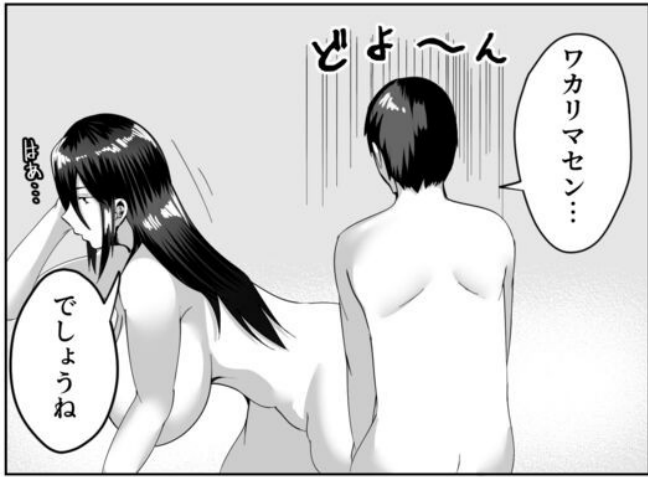

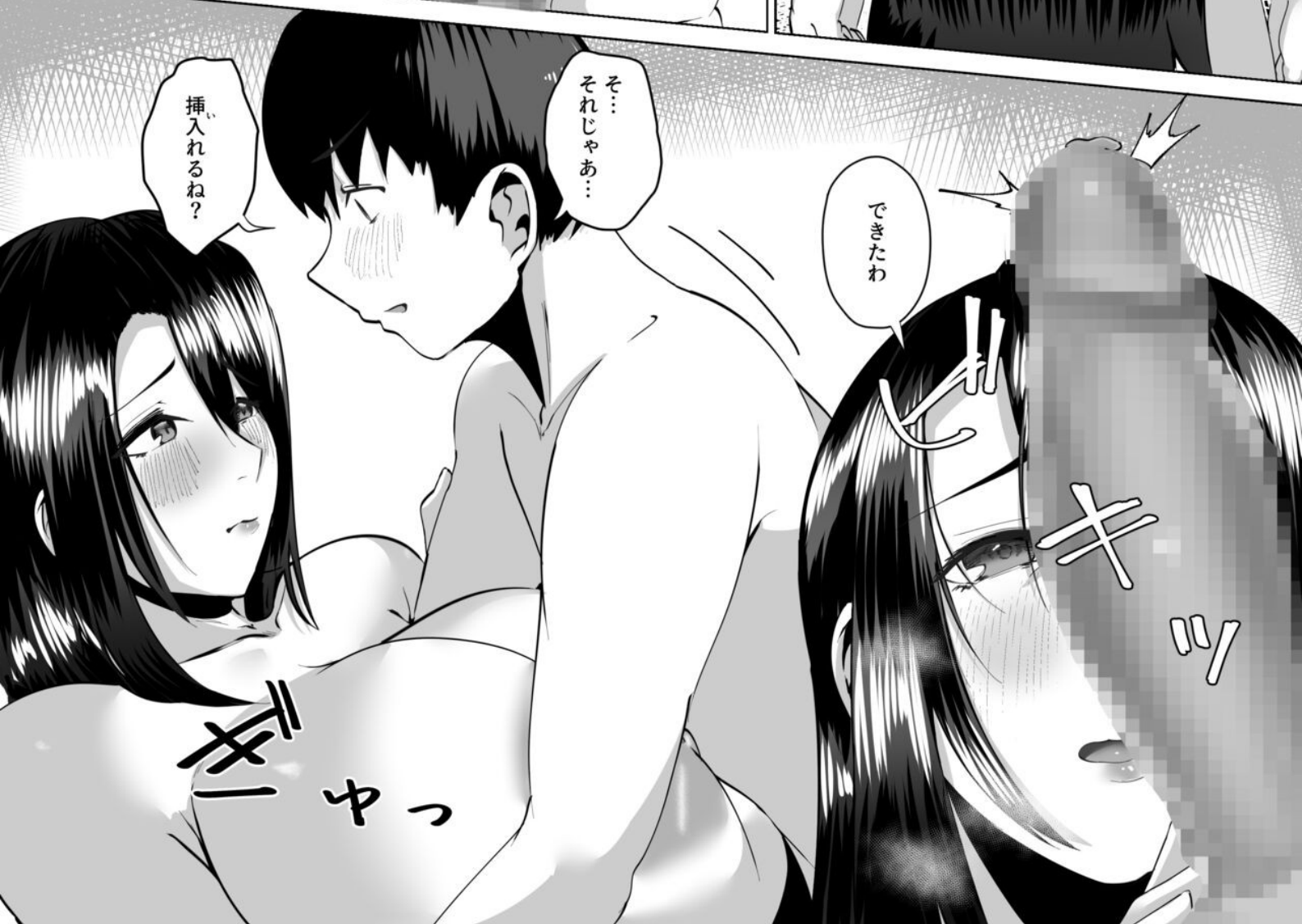



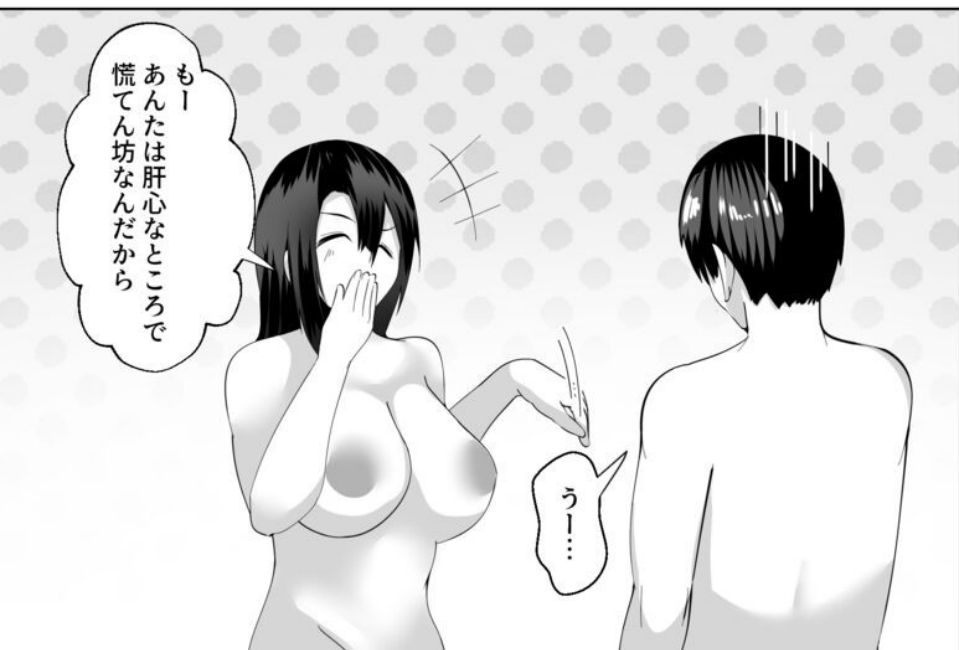

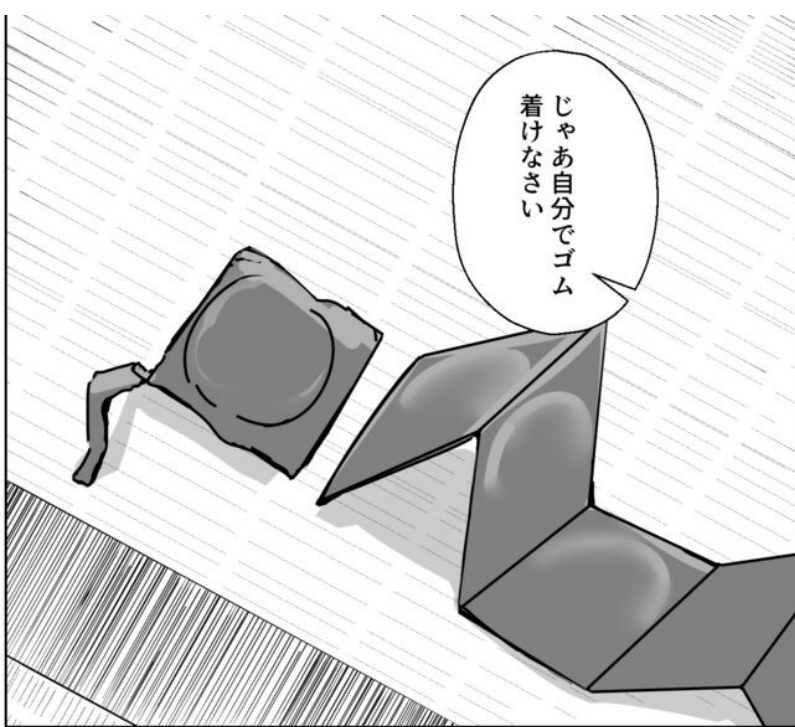



あつた  
温かつ!

さっきは  
わかんなかったけど

母さんの膣なか：  
こんな感じなんだ…



コウキのアレが私の膣なかで  
しっかりわかる…

お腹が突き上げられる  
みたい…



どうだ他の  
男どもっ!

俺の勝ちだっ!

母さんは誰にも  
渡さないっ!



コンドーム  
着けなおすから

またでちゃった…

ぷるる

あっ

……

ゴッ  
ゴッ



できたっ!!

ほんと  
しょうがないんだから…

焦ってガッついて…

ぬ、ぞ、っ

はあ…



自分が気持ちよくなりたいたいだけの  
独りよがりなセックス...



揉んで 挿入して

しゃぶって 舐めて

ちゃらら〜



よし!

母さん気持ち良いのを  
我慢してるのか...?



気持ちなの...

でもいい  
トコ当たっちゃうのは



きゃっ!?

顔を隠しちゃ  
ダメだ!!



おやすみなさい...

19時...

スツ

明日も学校でしょ？  
早めに寝るのよ

...うん

ズン  
ズン

今日のことは忘れなさい  
いいわね？



あら  
おはよう  
ご飯の支度するわね…



翌朝



いってきます…

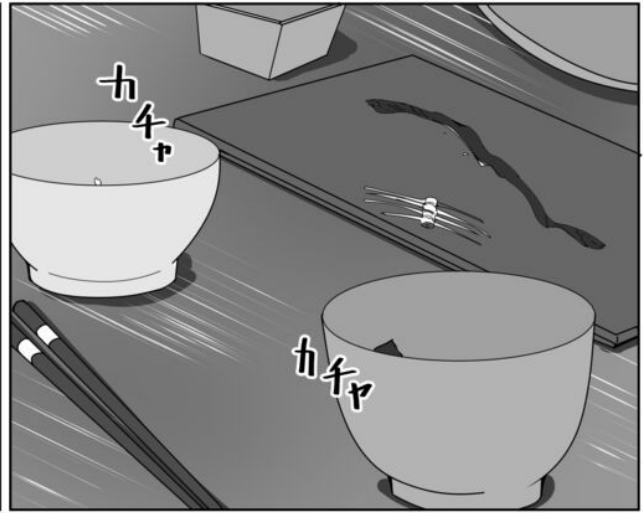

昨日のことは  
もう…

母さん普通だったな…



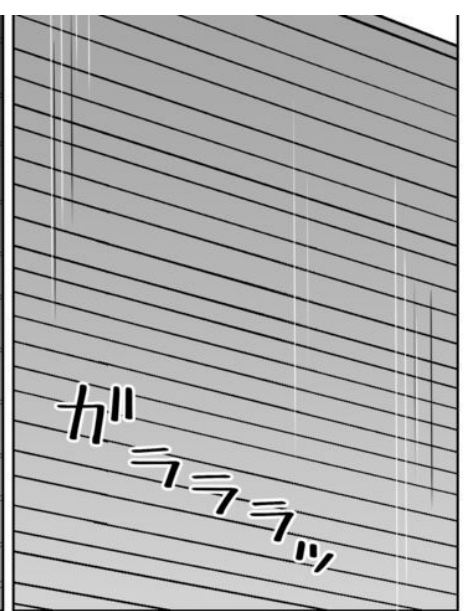

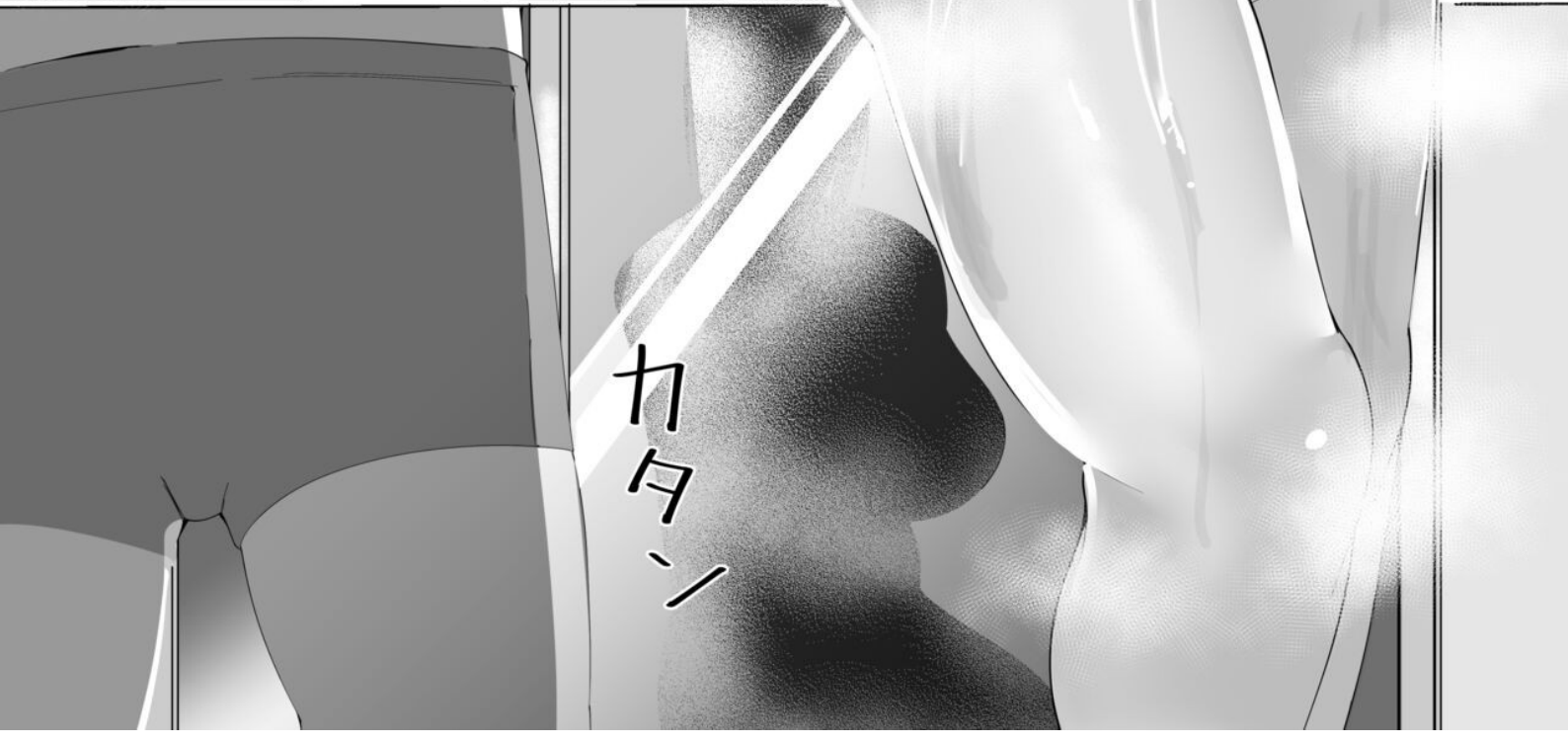





夢中で俺のちんこ  
しゃぶってる...

こんなエロい  
顔して

母さん...

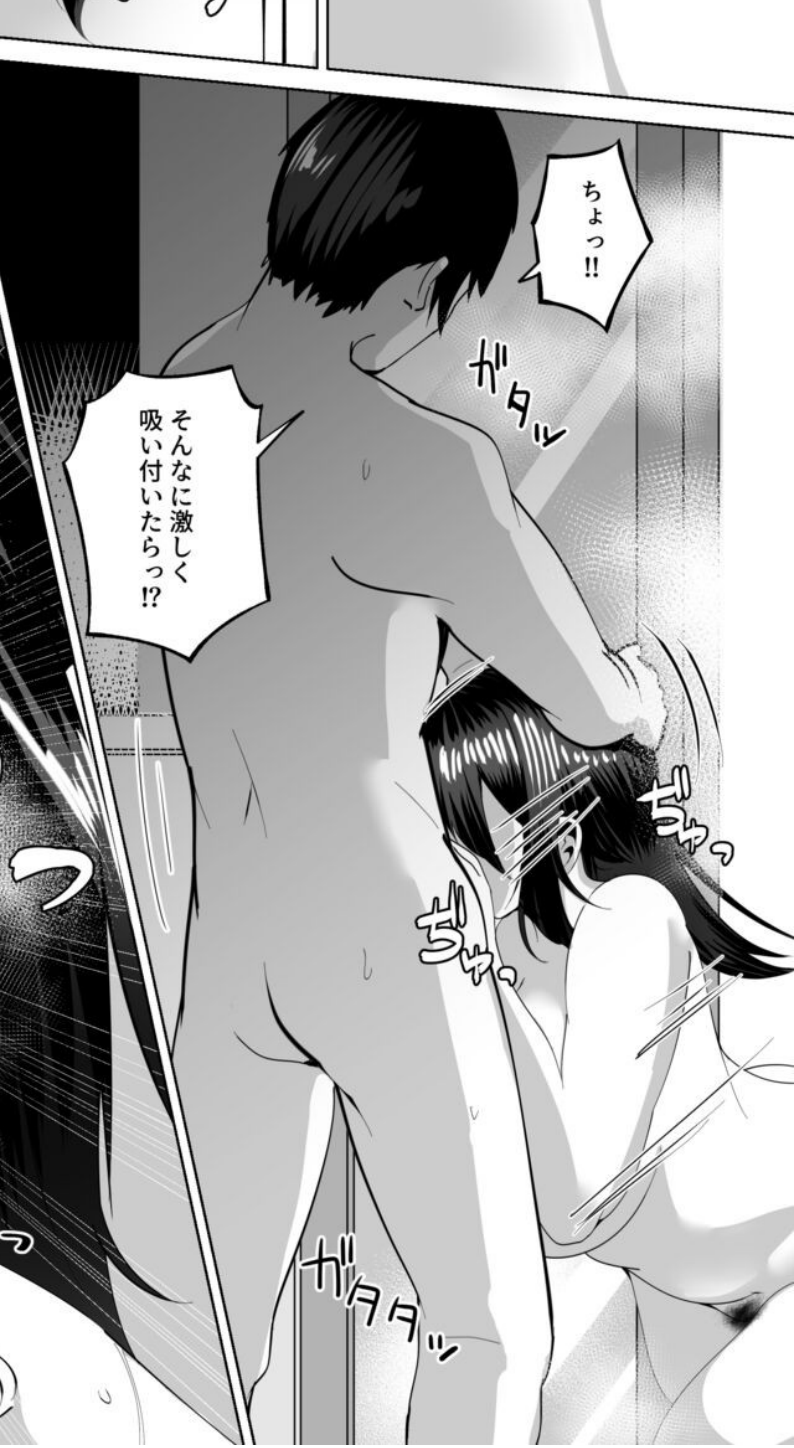

ちゅっ!!

そんなに激しく  
吸い付いたらっ!?

がたっ



ねえ...♡

フッ

フッ



濃いわ...

凄い匂い...

ちゅっ...♡

ちゅっ

ちゅっ

ちゅっ...♡



したいんですよ...?

仕方ないわね

フッ



飲んだ！  
僕の精液を!?

ヒキッ



母さんが誘ってる！

ちんこ欲しくて  
たまらないんだ！

いいの...  
コンドームしてないよ？

ゴクッ



きゅっ!!

かた...  
るけ...  
なっ!!



仕方ない!?

ギ...ッ



母さんは自分の性欲を  
全部僕のせいにして  
ごまかそうとしてるんだ!!

っ...っ

は...  
は...

そんな...



そんなに欲しいなら  
くれてやる!!

ゆりゆり

コッソッ

三々

三々

コッソ



頭の中  
僕のちんこで  
いっぱいなんだろ！

「仕方ない」とか「忘れろ」  
とか言って  
自分だけ常識ぶって

どうなんだよっ  
母さん！！

ピクッ  
ピクッ...

あー



あんたのちんこで  
いっぱいなのよ！

そうよ！！

悪い？！

私だっけずっと  
我慢してきたんだからあ！！

初めからそう言え！！

この淫乱女！！

いちゃ  
いちゃ  
いちゃ

ギョ  
ギョ

ギョ  
ギョ

ぽん  
ぽん

ぽん  
ぽん



じゃあまんこ  
絞めろっ!!

もっとちんぽ欲しい!!  
ちんぽ頂戴!!

淫乱でいい!!  
淫乱でいいからあ!!

イけっ!  
イけっ!

しゃぶ、しゃぶ、



ああああああ  
ああ♡♡♡♡

いくっ♡  
いくからあ♡♡

はっ、はっ、



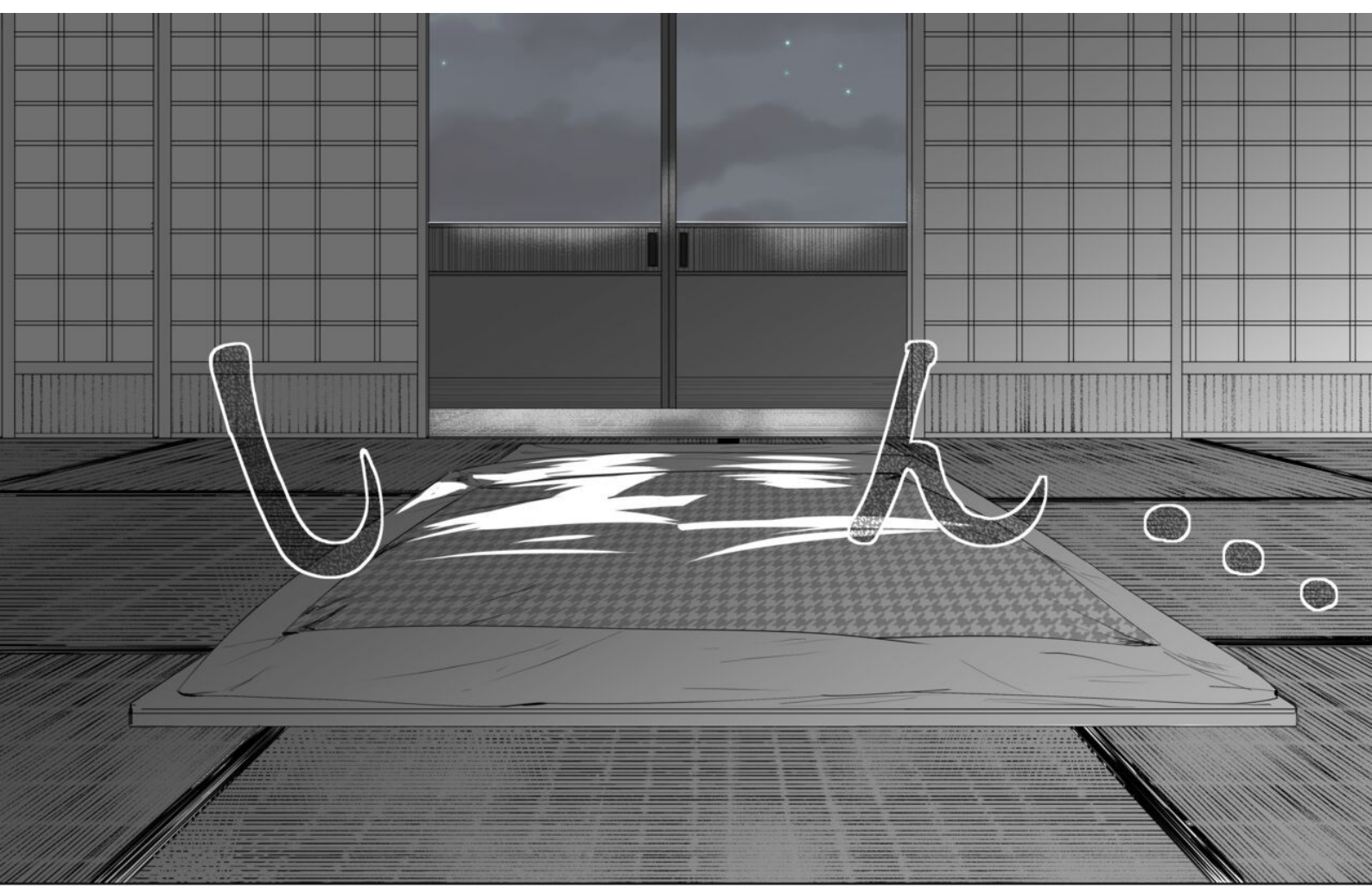

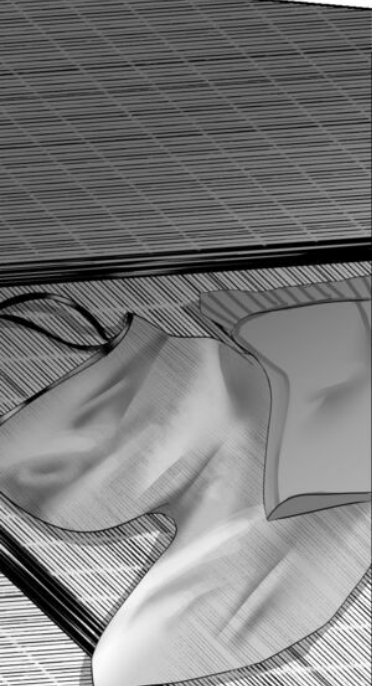







母さん  
聞いてよ

なに...??

好きだ...

私もコウキが好きよ

それは息子として?

どうかしら...

しゅ...

しゅ...

ほちゃん

ほちゃん

てか...  
もういきそう

ふふ...  
母さんも

一緒に  
いきたい...

いいわ  
いきましよう...

うっ  
いくよっ

あっ...  
いくっ...



いつくう...♡♡♡

あ

ゆ

く

ん

っ

とぶとっ

すごい射精た...

とぶとっ...

一緒にいっちゃったね...♡

その後も  
僕と母さんは何度も繋がった

空が白むまで何度果てたか  
わからない…

僕の求めに応えてくれる  
母さんの姿が愛しかった

ほちゃん

ほちゃん

そして

吉田商店街

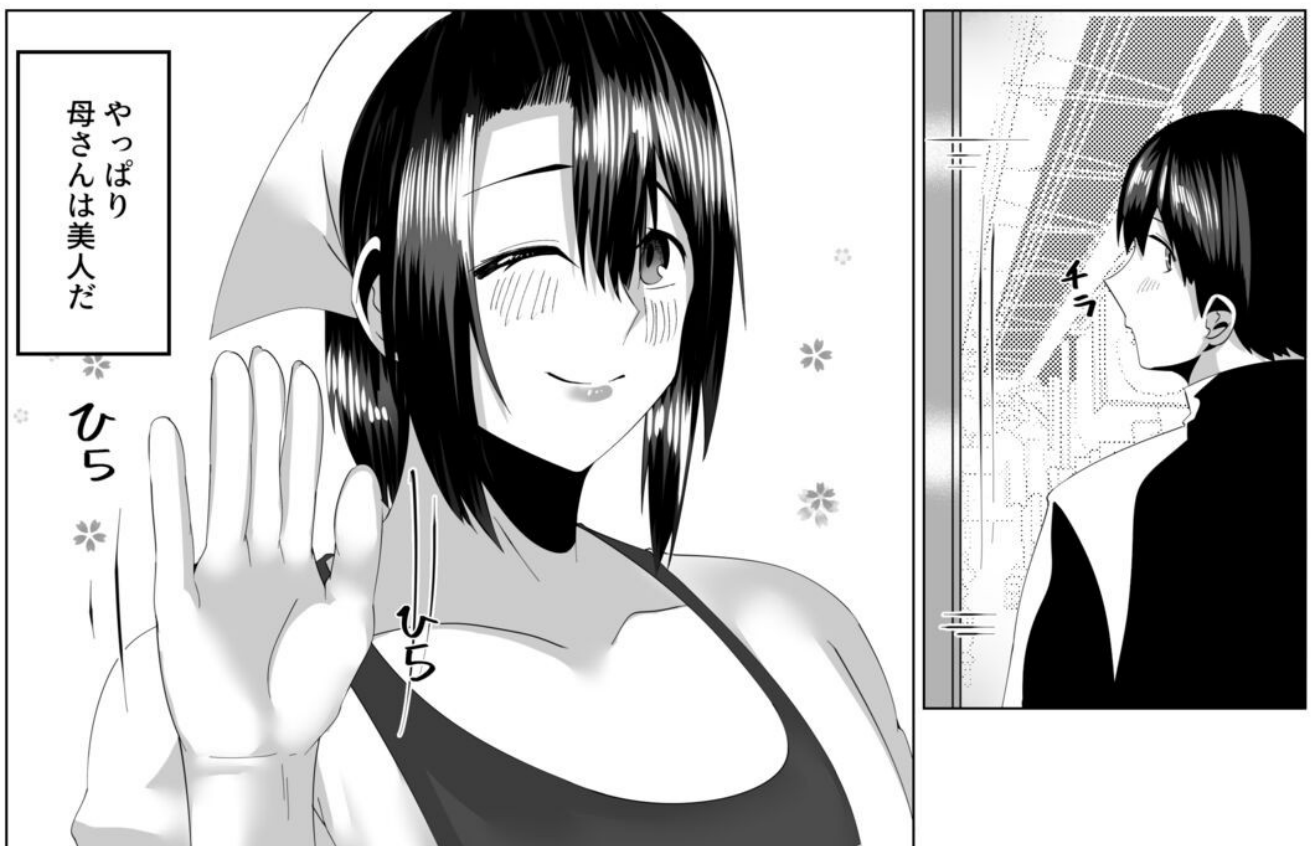

母さんは

# 看板娘

「肉欲に焦がれた母子の二夜」

